

2024 | Railway Power Solutions Ruggedized DC/DC Converters Product Portfolio



Company Profile

TRACO Electronic AG is a Swiss company with headquarters based in Baar, Switzerland. As a leading power supply specialist with more than 40 years experience we are dedicated to the design and manufacturing of high quality DC/DC and AC/DC power conversion products.

TRACO markets its products worldwide under the registered trademark TRACO POWER. Our mission is to provide our customers with optimal power supply solutions in terms of performance, quality and cost for their individual application.

Ruggedized DC/DC Converters For Railway and Industrial Applications

Ruggedized DC/DC converters for railway and industrial applications must withstand highest mechanical and thermal stresses. Even our smallest converters are subject to stringent requirements on safety, design-life and environmental operating conditions. The corresponding standards **EN 50155** and **EN 61373** are internationally recognized for electronic equipment on rail vehicles and are widely regarded as a proof of fitness for extreme environments outside of the transportation sector as well. All our railway DC/DC converters come with additional **IEC/EN/UL 62368-1** approvals for a wide range of demanding applications.

EN 50155 defines the minimum input voltage requirements for DC/DC converters as follows:

Bus Voltage	Continuous input voltage range	Brownout 100 ms	Transient 1 sec	Recommended input voltage ranges
24 VDC	16.8–30.0 V	14.4 V	33.6 V	9–36 VDC (4:1 wide) or 14–160 VDC (12:1 ultra wide)
37.5 VDC	26.2–47.0 V	22.5 V	52.5 V	18–75 VDC (4:1 wide) or 14–160 VDC (12:1 ultra wide)
48 VDC	33.6–60.0 V	28.8 V	67.2 V	18–75 VDC (4:1 wide) or 14–160 VDC (12:1 ultra wide)
72 VDC	50.4–90.0 V	43.2 V	100.8 V	43–160 VDC (4:1 wide) or 14–160 VDC (12:1 ultra wide)
96 VDC	67.2–120.0 V	57.6 V	134.4 V	43–160 VDC (4:1 wide) or 14–160 VDC (12:1 ultra wide)
110 VDC	77.0–137.5 V	66.0 V	154.0 V	43–160 VDC (4:1 wide) or 14–160 VDC (12:1 ultra wide)

EN 50155 sets the following additional requirements:

- Galvanic isolation to protect electronic circuits
- Limits on emission and susceptibility with respect to conducted and radiated electromagnetic interference
- Safe operation at relative humidity levels up to 95% for 30 consecutive days

EN 61373 certification guarantees the ability to continuously operate under severe mechanical stresses:

- Random vibration – frequency range of 5–150 Hz @ 5grms (5hrs per axis)
- Shock – peak acceleration of 5g/2g/1g (duration: 50ms/20ms/20ms.)

All TRACO POWER railway solutions offer highest reliability in harsh environments. Our 4:1 wide and 12:1 ultra wide input voltage range DC/DC converters go beyond the requirements of the **EN 50155**. Continuous operation is permitted between –40 to +85°C ambient temperature. Operation at higher ambient temperatures is possible with favorable derating characteristics. All our PCB-mounted converters are fully encapsulated for protection against moisture and air particles. Certification according to **EN 61373** guarantees highest resistance against mechanical shocks and vibration. For selected models, an internal class A EMI filter limits electromagnetic interference. All railway DC/DC converters come with additional **IEC/EN/UL 62368-1** safety approvals and are qualified for fire behavior according to **EN 45545-2**. Our manufacturing processes are **ISO 9001** certified to ensure every single product is safe, reliable and of highest quality.

Note: All dimension drawings in mm (inch)



DC/DC Converters 3-300 Watt 4:1 | 12:1

Features

- EN 50155 railway approvals
- Extended temperature range: -40 °C to +85 °C
- Ruggedized designs, EN61373 compliant for shock & vibration
- Wide and ultra-wide input voltage ranges: 9 - 36, 18 - 75, 43 - 160, 14 - 160 VDC
- Suitable for applications in harsh environments

- RIA 12 surge filters
- 3-year warranty

Additional Qualifications

- IEC/EN/UL 62368-1
- EN 45545-2
- RIA 12, NF F 01-510

Railway DC/DC Converters

SIP



3 - 6 W

DIP / Brick



3 - 200 W

Off-board



20 - 300 W

Surge Filter

DIP, 1.6 x 1



1 - 300 W



Railway DC/DC Converters (PCB Mounting)

	Footprint	Connection	Input	Housing	I/O isolation	Special function		
TMR 3WIR	SIP-8	Through-hole	4:1	Encapsulated	3000 VDC		3 watt	5
TEN 3WIRH	DIP-24	Through-hole	4:1	Encapsulated	4000 VAC	Remote on/off	3 watt	6
TMR 6WIR	SIP-8	Through-hole	4:1	Encapsulated	3000 VDC		6 watt	6
TEN 6WIRH	DIP-24	Through-hole	4:1	Encapsulated	4000 VAC	Remote on/off	6 watt	7
TEN 8WI	DIP-24	Through-hole	4:1	Encapsulated	1500 VDC	Remote on/off	8 watt	7
THN 10WIR	1" × 1"	Through-hole	4:1	Encapsulated	3000 VDC	Remote on/off	10 watt	8
THN 10UIR	1" × 1"	Through-hole	12:1	Encapsulated	3000 VDC	Remote on/off NEW	10 watt	8
TEN 10WIRH	DIP-24	Through-hole	4:1	Encapsulated	4000 VAC	Remote on/off	10 watt	9
THN 15WIR	1" × 1"	Through-hole	4:1	Encapsulated	3000 VDC	Remote on/off	15 watt	9
THN 15UIR	1" × 1"	Through-hole	12:1	Encapsulated	3000 VDC	Remote on/off NEW	15 watt	10
THN 20WIR	1" × 1"	Through-hole	4:1	Encapsulated	3000 VDC	Remote on/off	20 watt	10
THN 20UIR	1" × 1"	Through-hole	12:1	Encapsulated	3000 VDC	Remote on/off NEW	30 watt	11
TEN 20WIR	2" × 1"	Through-hole	4:1	Encapsulated	2250 VDC	Remote on/off	20 watt	11
TEN 20WIRH	1.6" × 1"	Through-hole	4:1	Encapsulated	4000 VAC	Remote on/off	20 watt	12
TEN 30UIR	2" × 1"	Through-hole	12:1	Encapsulated	3000 VDC	Remote on/off NEW	30 watt	12
THN 30WIR	1" × 1"	Through-hole	4:1	Encapsulated	3000 VDC	Remote on/off	30 watt	13
TEN 40WIR	2" × 1"	Through-hole	4:1	Encapsulated	2250 VDC	Remote on/off	40 watt	13
TEN 40WIRH	2" × 1"	Through-hole	4:1	Encapsulated	4000 VAC	Remote on/off	40 watt	14
TEN 40UIR	2" × 1"	Through-hole	12:1	Encapsulated	3000 VDC	Remote on/off NEW	40 watt	14
TEP 40UIR	Quarter-brick	Through-hole	12:1	Encapsulated	3000 VDC	Remote on/off	40 watt	15
TEN 60WIR	2" × 1"	Through-hole	4:1	Encapsulated	3000 VDC	Remote on/off	60 watt	15
TEP 60UIR	Quarter-brick	Through-hole	12:1	Encapsulated	3000 VDC	Remote on/off	60 watt	16
TEP 75WI	Half-brick	Through-hole	4:1	Encapsulated	3000 VDC	Remote on/off	75 watt	16
TEP 100UIR	Quarter-brick	Through-hole	12:1	Encapsulated	3000 VDC	Remote on/off	100 watt	17
TEP 100WIR	Half-brick	Through-hole	4:1	Encapsulated	3000 VDC	Remote on/off	100 watt	17
TEP 150UIR	Half-brick	Through-hole	12:1	Encapsulated	3000 VAC	Remote on/off NEW	150 watt	18
TEP 160WIR	Half-brick	Through-hole	4:1	Encapsulated	3000 VDC	Remote on/off	160 watt	18
TEP 200WIR	Half-brick	Through-hole	4:1	Encapsulated	3000 VDC	Remote on/off	200 watt	19
TEP 200UIR	Half-brick	Through-hole	12:1	Encapsulated	3000 VAC	Remote on/off NEW	200 watt	19

Railway DC/DC Converters (Off-Board Mounting)

	Footprint	Connection	Input	Housing	I/O isolation	Special function		
TEQ 20WIR	4.1" × 2.3"	Spring clamp	4:1	Encased	2250 VDC		20 watt	20
TEQ 40WIR	4.1" × 2.3"	Spring clamp	4:1	Encased	2250 VDC		40 watt	21
TEQ 100WIR	4" × 3" × 3.5"	Spring clamp	4:1	Encased	3000 VDC		100 watt	21
TEP 150WI	3.9" × 2.1"	Screw terminal	4:1	Encased	3000 VDC	Constant-current	150 watt	22
TEQ 160WIR	4" × 3" × 3.5"	Spring clamp	4:1	Encased	3000 VDC		160 watt	22
TEQ 200WIR	4" × 3" × 3.5"	Spring clamp	4:1	Encased	3000 VDC		200 watt	23
TEQ 300WIR	6" × 4" × 1.5"	Spring clamp	4:1	Encased	3000 VDC	Load sharing	300 watt	23

Accessories

	Footprint	Connection	Input	Housing	I/O isolation	Special function		
TFI	1.6" × 1"	THT	4:1	Encapsulated	–	RIA 12 surge filter 0–300 watt		24

Railway DC/DC Converters (PCB Mounting)

5 – 200 watt

- Through-hole Technology (THT) PCB mounting
- Fully encapsulated
- Fully regulated outputs
- EN 50155 approved for rolling stock
- EN 61373 approved for shock & vibration
- Extended operating temperature range: $-40\text{ }^{\circ}\text{C}$ up to $+105\text{ }^{\circ}\text{C}$ (model dependent)
- Ultra-wide and wide input voltage ranges: 9 – 36, 18 – 75, 43 – 160, 14 – 160 VDC
- 3-year product warranty



TMR 3WIR

3 Watt

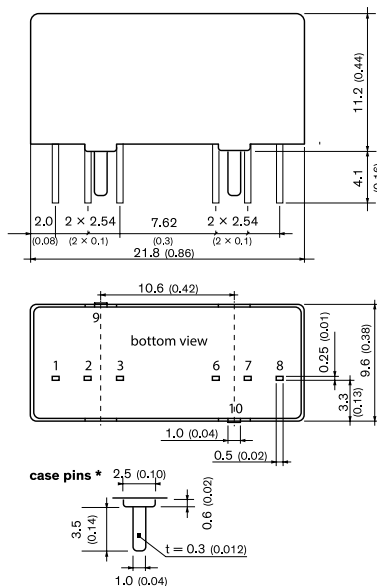

- Compact SIP-8 metal case
- EN 50155 railway approval
- Ultra wide 4:1 Input: 9–36, 18–75 and 43–160 VDC
- I/O-isolation 3'000 VDC
- Fully regulated outputs
- Operating temperature range $-40\text{ }^{\circ}\text{C}$ to $+90\text{ }^{\circ}\text{C}$
- Short circuit protection and current limitation
- Remote On/Off
- 3-year product warranty

Pinout		
Pin	Single Output	Dual Output
1	-Vin (GND)	-Vin (GND)
2	+Vin (Vcc)	+Vin (Vcc)
3	Remote	Remote
6	+Vout	+Vout
7	-Vout	Common
8	NC	-Vout
9, 10	Case	Case

Model	Input Voltage Range	Output		Efficiency
		Vnom	I _{max}	
TMR 3-2410WIR	9 – 36 VDC (24 VDC nom.)	3.3 VDC	700 mA	76%
TMR 3-2411WIR		5 VDC	600 mA	81%
TMR 3-2419WIR		9 VDC	333 mA	81%
TMR 3-2412WIR		12 VDC	250 mA	83%
TMR 3-2413WIR		15 VDC	200 mA	83%
TMR 3-2415WIR		24 VDC	125 mA	82%
TMR 3-2421WIR		±5 VDC	300 mA	80%
TMR 3-2422WIR		±12 VDC	125 mA	82%
TMR 3-2423WIR		±15 VDC	100 mA	82%
TMR 3-4810WIR		18 – 75 VDC (48 VDC nom.)	3.3 VDC	700 mA
TMR 3-4811WIR	5 VDC		600 mA	81%
TMR 3-4819WIR	9 VDC		333 mA	81%
TMR 3-4812WIR	12 VDC		250 mA	82%
TMR 3-4813WIR	15 VDC		200 mA	82%
TMR 3-4815WIR	24 VDC		125 mA	82%
TMR 3-4821WIR	±5 VDC		300 mA	80%
TMR 3-4822WIR	±12 VDC		125 mA	82%
TMR 3-4823WIR	±15 VDC		100 mA	82%
TMR 3-7210WIR	43 – 160 VDC (110 VDC nom.)		3.3 VDC	700 mA
TMR 3-7211WIR		5 VDC	600 mA	80%
TMR 3-7219WIR		9 VDC	333 mA	81%
TMR 3-7212WIR		12 VDC	250 mA	82%
TMR 3-7213WIR		15 VDC	200 mA	83%
TMR 3-7215WIR		24 VDC	125 mA	83%
TMR 3-7221WIR		±5 VDC	300 mA	80%
TMR 3-7222WIR		±12 VDC	125 mA	83%
TMR 3-7223WIR		±15 VDC	100 mA	81%

TEN 3WIRH 3 Watt

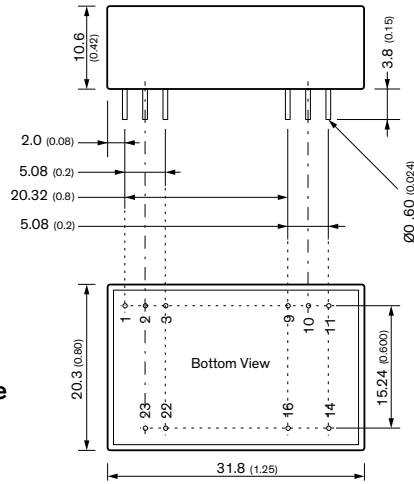

- Industrial standard DIP-24 package
- 3000 VAC reinforced I/O-isolation
- Wide 4:1 input voltage range: 36 – 160 VDC
- EN 50155 approval for railway applications
- Thermal shock and vibration resistant according EN 61373
- High efficiency up to 85%
- Operating temperature range -40°C to +95°C
- Under voltage lock-out circuit
- Remote On/Off and Trim function
- 3-year product warranty

Pinout		
Pin	Single	Dual
1	Ctrl	Ctrl
2	-Vin	-Vin
3	-Vin	-Vin
9	NC	Common
10	Trim (option)	Trim (option)
11	NC	-Vout
14	+Vout	+Vout
16	-Vout	Common
22	+Vin	+Vin
23	+Vin	+Vin

Model	Input Voltage Range	Output		Efficiency
		Vnom	I _{max}	
TEN 3-11010WIRH	36 – 160 VDC	3.3 VDC	1000 mA	80%
TEN 3-11011WIRH		5 VDC	600 mA	82%
TEN 3-11012WIRH		12 VDC	250 mA	85%
TEN 3-11013WIRH		15 VDC	200 mA	84%
TEN 3-11015WIRH		24 VDC	125 mA	85%
TEN 3-11021WIRH		±5 VDC	±300 mA	81%
TEN 3-11022WIRH		±12 VDC	±125 mA	84%
TEN 3-11023WIRH		±15 VDC	±100 mA	85%

TMR 6WIR 6 Watt

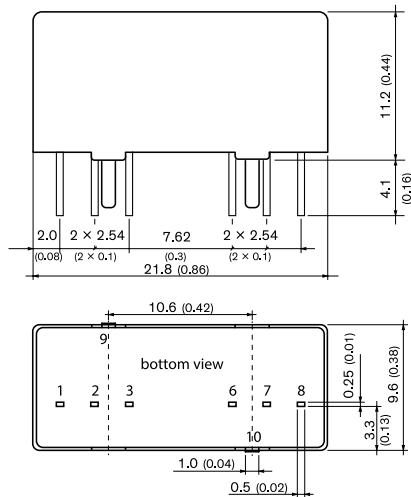

- Compact SIP-8 metal case
- EN 50155 railway approval
- Ultra wide 4:1 Input: 9–36, 18–75 and 43–160 VDC
- I/O-isolation 3'000 VDC
- Fully regulated outputs
- Operating temperature range -40°C to +80°C
- Short circuit protection and current limitation
- Remote On/Off
- 3-year product warranty

Pinout		
Pin	Single Output	Dual Output
1	-Vin (GND)	-Vin (GND)
2	+Vin (Vcc)	+Vin (Vcc)
3	Remote	Remote
6	+Vout	+Vout
7	-Vout	Common
8	NC	-Vout
9, 10	Case	Case

Model	Input Voltage Range	Output		Efficiency
		Vnom	I _{max}	
TMR 6-2410WIR	9 – 36 VDC (24 VDC nom.)	3.3 VDC	1500 mA	81%
TMR 6-2411WIR		5 VDC	1200 mA	84%
TMR 6-2419WIR		9VDC	666 mA	86%
TMR 6-2412WIR		12 VDC	500 mA	87%
TMR 6-2413WIR		15 VDC	400 mA	88%
TMR 6-2415WIR		24 VDC	250 mA	87%
TMR 6-2421WIR		±5 VDC	600 mA	84%
TMR 6-2422WIR		±12 VDC	250 mA	87%
TMR 6-2423WIR		±15 VDC	200 mA	87%
TMR 6-4810WIR		18 – 75 VDC (48 VDC nom.)	3.3 VDC	1500 mA
TMR 6-4811WIR	5 VDC		1200 mA	84%
TMR 6-4819WIR	9VDC		666 mA	85%
TMR 6-4812WIR	12 VDC		500 mA	87%
TMR 6-4813WIR	15 VDC		400 mA	87%
TMR 6-4815WIR	24 VDC		250 mA	87%
TMR 6-4821WIR	±5 VDC		600 mA	84%
TMR 6-4822WIR	±12 VDC		250 mA	87%
TMR 6-4823WIR	±15 VDC		200 mA	87%
TMR 6-7210WIR	43 – 160 VDC (110 VDC nom.)		3.3 VDC	1500 mA
TMR 6-7211WIR		5 VDC	1200 mA	83%
TMR 6-7219WIR		9VDC	666 mA	85%
TMR 6-7212WIR		12 VDC	500 mA	86%
TMR 6-7213WIR		15 VDC	400 mA	86%
TMR 6-7215WIR		24 VDC	250 mA	86%
TMR 6-7221WIR		±5 VDC	600 mA	83%
TMR 6-7222WIR		±12 VDC	250 mA	86%
TMR 6-7223WIR		±15 VDC	200 mA	86%

TEN 6WIRH

6 Watt

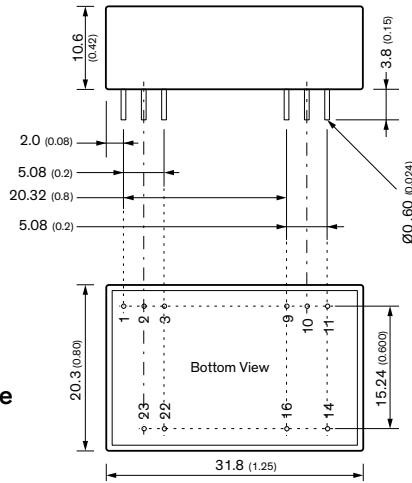

- Industrial standard DIP-24 package
- 3000 VAC reinforced I/O-isolation
- Wide 4:1 input voltage range: 36 – 160 VDC
- EN 50155 approval for railway applications
- Thermal shock and vibration resistant according EN 61373
- High efficiency up to 87%
- Operating temperature range -40°C to +85°C
- Under voltage lock-out circuit
- Remote On/Off and Trim function
- 3-year product warranty

Pinout		
Pin	Single	Dual
1	Ctrl	Ctrl
2	-Vin	-Vin
3	-Vin	-Vin
9	NC	Common
10	Trim (option)	Trim (option)
11	NC	-Vout
14	+Vout	+Vout
16	-Vout	Common
22	+Vin	+Vin
23	+Vin	+Vin

Model	Input Voltage Range	Output		Efficiency
		Vnom	I _{max}	
TEN 6-11010WIRH	36 – 160 VDC	3.3 VDC	1800 mA	83%
TEN 6-11011WIRH		5 VDC	1200 mA	86%
TEN 6-11012WIRH		12 VDC	500 mA	87%
TEN 6-11013WIRH		15 VDC	400 mA	86%
TEN 6-11015WIRH		24 VDC	250 mA	86%
TEN 6-11021WIRH		±5 VDC	±600 mA	83%
TEN 6-11022WIRH		±12 VDC	±250 mA	86%
TEN 6-11023WIRH		±15 VDC	±200 mA	86%

TEN 8WI

8 Watt

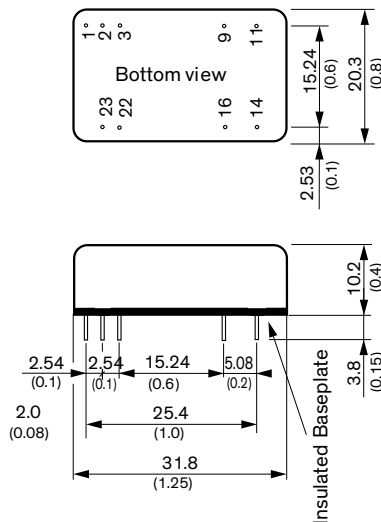

- DIP-24 metal package
- Ultra wide 4:1 input voltage range 9–36, 18–75, 43–160 VDC
- EN 50155 approval for railway applications
- Thermal shock and vibration resistant according EN 61373
- High efficiency up to 88%
- No minimum load required
- Operating temperature range -40°C to +85°C
- Remote On/Off
- Under voltage lock-out circuit
- Shielded metal case with insulated base plate
- Lead free design, RoHS compliant
- 3-year product warranty

Pinout		
Pin	Single	Dual
1	Remote On/Off	Remote On/Off
2	-Vin (GND)	-Vin (GND)
3	-Vin (GND)	-Vin (GND)
9	NC	Common
11	NC	-Vout
14	+Vout	+Vout
16	-Vout	Common
22	+Vin (Vcc)	+Vin (Vcc)
23	+Vin (Vcc)	+Vin (Vcc)

Model	Input Voltage Range	Output		Efficiency
		Vnom	I _{max}	
TEN 8-2410WI	9 – 36 VDC (24 VDC nom.)	3.3 VDC	2400 mA	85%
TEN 8-2411WI		5 VDC	1600 mA	87%
TEN 8-2412WI		12 VDC	666 mA	86%
TEN 8-2413WI		15 VDC	533 mA	86%
TEN 8-2421WI		±5 VDC	±800 mA	84%
TEN 8-2422WI		±12 VDC	±333 mA	86%
TEN 8-2423WI	±15 VDC	±267 mA	86%	
TEN 8-4810WI	18 – 75 VDC (48 VDC nom.)	3.3 VDC	2400 mA	85%
TEN 8-4811WI		5 VDC	1600 mA	87%
TEN 8-4812WI		12 VDC	666 mA	87%
TEN 8-4813WI		15 VDC	533 mA	88%
TEN 8-4821WI		±5 VDC	±800 mA	84%
TEN 8-4822WI		±12 VDC	±333 mA	87%
TEN 8-4823WI	±15 VDC	±267 mA	87%	
TEN 8-7210WI	43 – 160 VDC (110 VDC nom.)	3.3 VDC	2400 mA	84%
TEN 8-7211WI		5 VDC	1600 mA	85%
TEN 8-7212WI		12 VDC	666 mA	86%
TEN 8-7213WI		15 VDC	533 mA	86%
TEN 8-7221WI		±5 VDC	±800 mA	82%
TEN 8-7222WI		±12 VDC	±333 mA	85%
TEN 8-7223WI	±15 VDC	±267 mA	85%	

THN 10WIR

10 Watt

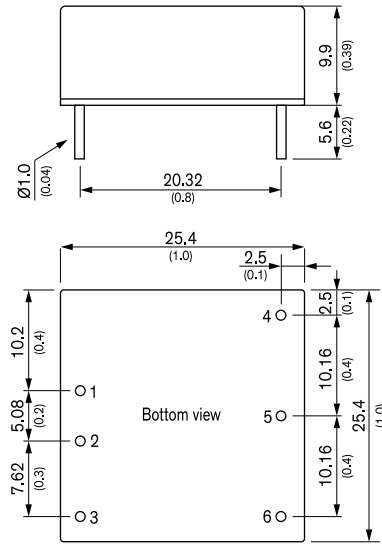

- Compact 1" x 1" x 0.4" standard package
- Wide 4:1 input voltage range 9–36, 18–75, 36–160 VDC
- EN 50155 and EN 61373 approval for railway applications
- Qualification for fire behaviour according to EN 45545-2
- I/O-isolation 3'000 VDC
- High efficiency up to 90%
- Operating temperature range -40°C to +90°C
- Under voltage lock-out circuit
- Adjustable output voltage & Remote On/Off

Model	Input Voltage Range	Output Vnom	I _{max}	Efficiency
THN 10-2410WIR	9 – 36 VDC (24 VDC nom.)	3.3 VDC	3000 mA	87%
THN 10-2411WIR		5 VDC	2000 mA	89%
THN 10-2412WIR		12 VDC	830 mA	89%
THN 10-2413WIR		15 VDC	670 mA	90%
THN 10-2415WIR		24 VDC	420 mA	90%
THN 10-2421WIR		±5 VDC	±1000 mA	86%
THN 10-2422WIR		±12 VDC	±416 mA	89%
THN 10-2423WIR		±15 VDC	±333 mA	89%
THN 10-2425WIR		±24 VDC	±210 mA	90%
THN 10-4810WIR		18 – 75 VDC (48 VDC nom.)	3.3 VDC	3000 mA
THN 10-4811WIR	5 VDC		2000 mA	89%
THN 10-4812WIR	12 VDC		830 mA	89%
THN 10-4813WIR	15 VDC		670 mA	90%
THN 10-4815WIR	24 VDC		420 mA	90%
THN 10-4821WIR	±5 VDC		±1000 mA	86%
THN 10-4822WIR	±12 VDC		±416 mA	89%
THN 10-4823WIR	±15 VDC		±333 mA	89%
THN 10-4825WIR	±24 VDC		±210 mA	90%
THN 10-7210WIR	36 – 160 VDC (110 VDC nom.)		3.3 VDC	3000 mA
THN 10-7211WIR		5 VDC	2000 mA	88%
THN 10-7212WIR		12 VDC	830 mA	89%
THN 10-7213WIR		15 VDC	670 mA	89%
THN 10-7215WIR		24 VDC	420 mA	89%
THN 10-7221WIR		±5 VDC	±1000 mA	85%
THN 10-7222WIR		±12 VDC	±416 mA	89%
THN 10-7223WIR		±15 VDC	±333 mA	89%
THN 10-7225WIR		±24 VDC	±210 mA	89%

Pinout		
Pin	Single	Dual
1	+Vin	+Vin
2	-Vin	-Vin
3	Ctrl	Ctrl
4	+Vout	+Vout
5	Trim	Common
6	-Vout	-Vout

THN 10UIR

NEW!

10 Watt

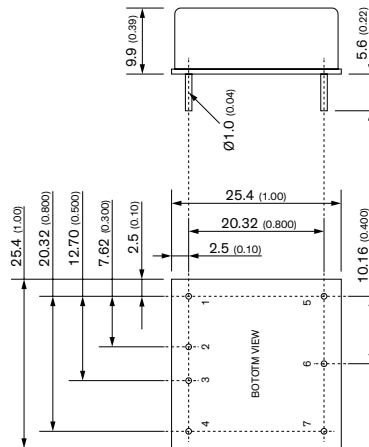

- Compact 1" x 1" housing
- Ultra-wide 12:1 input voltage range: 9–75, 14–160 VDC
- -40°C up to +70°C natural convection cooling without derating
- EN 50155, EN 45545-2 and EN 61373 certified
- Dedicated holdup capacitor connection
- Fully encapsulated
- Reinforced 3000VAC I/O isolation
- Remote on/off and trim function
- Protection against short-circuit (SCP), overvoltage (OVP) and overtemperature (OTP)
- 3-year product warranty

Model	Input Voltage Range	Output Vnom	I _{max}	Efficiency	
THN 10-3610UIR	9 – 75 VDC (36 VDC nom.)	3.3 VDC	3000 mA	85%	
THN 10-3611UIR		5.1 VDC	2000 mA	86%	
THN 10-3612UIR		12 VDC	830 mA	88%	
THN 10-3613UIR		15 VDC	670 mA	88%	
THN 10-3615UIR		24 VDC	420 mA	88%	
THN 10-3621UIR		±5 VDC	±1000 mA	83%	
THN 10-3622UIR		±12 VDC	±416 mA	87%	
THN 10-3623UIR		±15 VDC	±333 mA	87%	
THN 10-7210UIR		14 – 160 VDC (72 VDC nom.)	3.3 VDC	3000 mA	86%
THN 10-7211UIR			5.1 VDC	2000 mA	87%
THN 10-7212UIR	12 VDC		830 mA	88%	
THN 10-7213UIR	15 VDC		670 mA	88%	
THN 10-7215UIR	24 VDC		420 mA	88%	
THN 10-7221UIR	±5 VDC		±1000 mA	84%	
THN 10-7222UIR	±12 VDC		±416 mA	87%	
THN 10-7223UIR	±15 VDC		±333 mA	87%	

Pinout		
Pin	Single	Dual
1*	No Pin / BUS / UVLO	
2	+Vin	
3	-Vin	
4	Remote On/Off	
5	+Vout	
6	Trim	Common
7	-Vout	

* If neither BUS nor UVLO is present
 ** UVLO function is optional

TEN 10WIRH 10 Watt

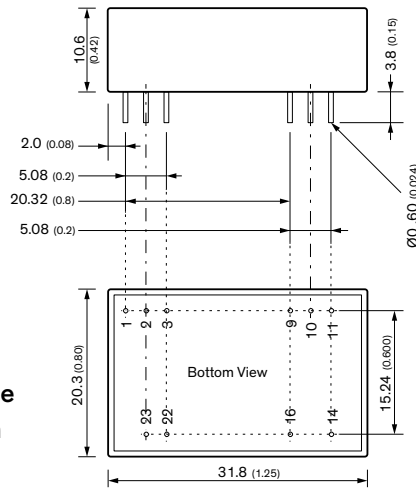

- Industrial standard DIP-24 package
- 3000 VAC reinforced I/O-isolation
- Wide 4:1 input voltage range: 36 – 160 VDC
- EN 50155 approval for railway applications
- Thermal shock and vibration resistant according EN 61373
- High efficiency up to 88%
- Operating temperature range -40°C to +85°C
- Under voltage lock-out circuit
- Remote On/Off and Trim function
- 3-year product warranty

Pinout		
Pin	Single	Dual
1	Ctrl	Ctrl
2	- Vin	- Vin
3	- Vin	- Vin
9	NC	Common
10	Trim (option)	Trim (option)
11	NC	- Vout
14	+ Vout	+ Vout
16	- Vout	Common
22	+ Vin	+ Vin
23	+ Vin	+ Vin

Model	Input Voltage Range	Output		Efficiency
		Vnom	I _{max}	
TEN 10-11010WIRH	36 – 160 VDC	3.3 VDC	2500 mA	83%
TEN 10-11011WIRH		5 VDC	2000 mA	87%
TEN 10-11012WIRH		12 VDC	830 mA	88%
TEN 10-11013WIRH		15 VDC	670 mA	88%
TEN 10-11015WIRH		24 VDC	416 mA	88%
TEN 10-11021WIRH		±5 VDC	±1000 mA	84%
TEN 10-11022WIRH		±12 VDC	±416 mA	87%
TEN 10-11023WIRH		±15 VDC	±333 mA	87%

THN 15WIR 15 Watt

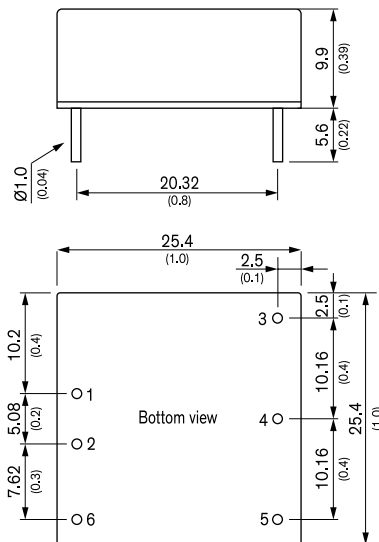

- Compact 1" x 1" x 0.4" standard package
- Wide 4:1 input voltage range 9–36, 18–75, 36–160 VDC
- EN 50155 and EN 61373 approval for railway applications
- Qualification for fire behaviour according to EN 45545-2
- I/O-isolation 3'000 VDC
- High efficiency up to 91%
- Operating temperature range -40°C to +90°C
- Under voltage lock-out circuit
- Adjustable output voltage & Remote On/Off

Pinout		
Pin	Single	Dual
1	+Vin	+Vin
2	-Vin	-Vin
3	+Vout	+Vout
4	Trim	Common
5	-Vout	-Vout
6	Remote On/Off	Remote On/Off

Model	Input Voltage Range	Output		Efficiency
		Vnom	I _{max}	
THN 15-2410WIR	9 – 36 VDC (24 VDC nom.)	3.3 VDC	4500 mA	88%
THN 15-2411WIR		5 VDC	3000 mA	90%
THN 15-2412WIR		12 VDC	1300 mA	89%
THN 15-2413WIR		15 VDC	1000 mA	90%
THN 15-2415WIR		24 VDC	625 mA	91%
THN 15-2421WIR		±5 VDC	±1500 mA	87%
THN 15-2422WIR		±12 VDC	±625 mA	90%
THN 15-2423WIR		±15 VDC	±500 mA	90%
THN 15-2425WIR		±24 VDC	±315 mA	91%
THN 15-4810WIR		18 – 75 VDC (48 VDC nom.)	3.3 VDC	4500 mA
THN 15-4811WIR	5 VDC		3000 mA	90%
THN 15-4812WIR	12 VDC		1300 mA	89%
THN 15-4813WIR	15 VDC		1000 mA	90%
THN 15-4815WIR	24 VDC		625 mA	91%
THN 15-4821WIR	±5 VDC		±1500 mA	87%
THN 15-4822WIR	±12 VDC		±625 mA	90%
THN 15-4823WIR	±15 VDC		±500 mA	90%
THN 15-4825WIR	±24 VDC		±315 mA	90%
THN 15-7210WIR	36 – 160 VDC (110 VDC nom.)		3.3 VDC	4500 mA
THN 15-7211WIR		5 VDC	3000 mA	89%
THN 15-7212WIR		12 VDC	1300 mA	89%
THN 15-7213WIR		15 VDC	1000 mA	89%
THN 15-7215WIR		24 VDC	625 mA	90%
THN 15-7221WIR		±5 VDC	±1500 mA	86%
THN 15-7222WIR		±12 VDC	±625 mA	89%
THN 15-7223WIR		±15 VDC	±500 mA	89%
THN 15-7225WIR		±24 VDC	±315 mA	90%

THN 15UIR **NEW!** **15 Watt**

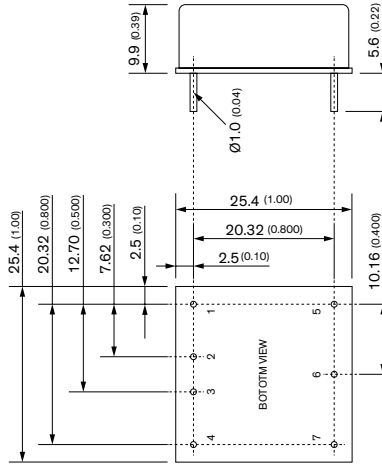

- Compact 1" x 1" housing
- Ultra-wide 12:1 input voltage range: 9–75, 14–160 VDC
- –40°C up to +70°C natural convection cooling without derating
- EN 50155, EN 45545-2 and EN 61373 certified
- Dedicated holdup capacitor connection
- Fully encapsulated
- Reinforced 3000VAC I/O isolation
- Remote on/off and trim function
- Protection against short-circuit (SCP), overvoltage (OVP) and overtemperature (OTP)
- 3-year product warranty

Pinout		
Pin	Single	Dual
1*	No Pin / BUS / UVLO	
2	+Vin	
3	-Vin	
4	Remote On/Off	
5	+Vout	
6	Trim	Common
7	-Vout	

* If neither BUS nor UVLO is present
 ** UVLO function is optional

Model	Input Voltage Range	Output		Efficiency
		Vnom	I _{max}	
THN 15-3611UIR	9 – 75 VDC (36 VDC nom.)	5.1 VDC	3'000 mA	87%
THN 15-3612UIR		12 VDC	1'250 mA	88%
THN 15-3613UIR		15 VDC	1'000 mA	88%
THN 15-3615UIR		24 VDC	625 mA	88%
THN 15-3622UIR		+12 VDC	625 mA	87%
THN 15-3623UIR	+15 VDC	500 mA	88%	
THN 15-7211UIR	14 – 160 VDC (72 VDC nom.)	5.1 VDC	3'000 mA	87%
THN 15-7212UIR		12 VDC	1'250 mA	88%
THN 15-7213UIR		15 VDC	1'000 mA	87%
THN 15-7215UIR		24 VDC	625 mA	87%
THN 15-7222UIR		+12 VDC	625 mA	87%
THN 15-7223UIR		+15 VDC	500 mA	87%

THN 20WIR **20 Watt**

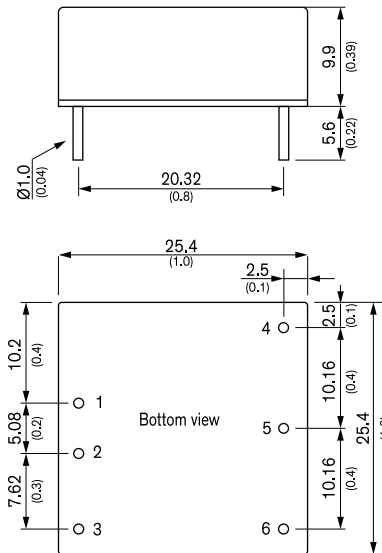

- Compact 1" x 1" x 0.4" standard package
- Wide 4:1 input voltage range 9–36, 18–75, 36–160 VDC
- EN 50155 and EN 61373 approval for railway applications
- Qualification for fire behaviour according to EN 45545-2
- I/O-isolation 3'000 VDC
- High efficiency up to 91%
- Operating temperature range –40°C to +90°C
- Under voltage lock-out circuit
- Adjustable output voltage & Remote On/Off

Pinout		
Pin	Single	Dual
1	+Vin	+Vin
2	-Vin	-Vin
3	Ctrl	Ctrl
4	+Vout	+Vout
5	Trim	Common
6	-Vout	-Vout

Model	Input Voltage Range	Output		Efficiency
		Vnom	I _{max}	
THN 20-2410WIR	9 – 36 VDC (24 VDC nom.)	3.3 VDC	5500 mA	88%
THN 20-2411WIR		5 VDC	4000 mA	89%
THN 20-2412WIR		12 VDC	1670 mA	89%
THN 20-2413WIR		15 VDC	1330 mA	89%
THN 20-2415WIR		24 VDC	833 mA	91%
THN 20-2422WIR		±12 VDC	±833 mA	89%
THN 20-2423WIR		±15 VDC	±667 mA	90%
THN 20-2425WIR	±24 VDC	±417 mA	91%	
THN 20-4810WIR	18 – 75 VDC (48 VDC nom.)	3.3 VDC	5500 mA	89%
THN 20-4811WIR		5 VDC	4000 mA	90%
THN 20-4812WIR		12 VDC	1670 mA	89%
THN 20-4813WIR		15 VDC	1330 mA	90%
THN 20-4815WIR		24 VDC	833 mA	91%
THN 20-4822WIR		±12 VDC	±833 mA	89%
THN 20-4823WIR		±15 VDC	±667 mA	90%
THN 20-4825WIR	±24 VDC	±417 mA	91%	
THN 20-7210WIR	36 – 160 VDC (110 VDC nom.)	3.3 VDC	5500 mA	89%
THN 20-7211WIR		5 VDC	4000 mA	90%
THN 20-7212WIR		12 VDC	1670 mA	90%
THN 20-7213WIR		15 VDC	1330 mA	90%
THN 20-7215WIR		24 VDC	833 mA	91%
THN 20-7222WIR		±12 VDC	±833 mA	90%
THN 20-7223WIR		±15 VDC	±667 mA	90%
THN 20-7225WIR	±24 VDC	±417 mA	91%	

THN 20UIR

NEW!

20 Watt

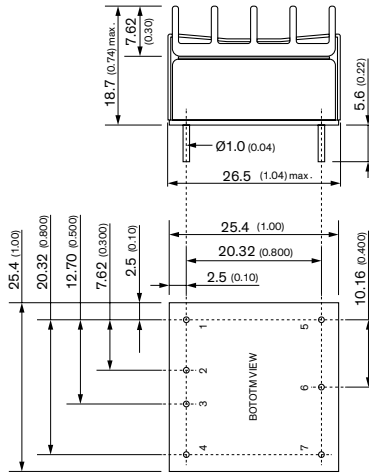

- Compact 1" x 1" housing
- Ultra-wide 12:1 input voltage range: 9–75, 14–160 VDC
- -40°C up to +70°C natural convection cooling without derating
- EN 50155, EN 45545-2 and EN 61373 certified
- Dedicated holdup capacitor connection
- Fully encapsulated
- Reinforced 3000VAC I/O isolation
- Remote on/off and trim function
- Protection against short-circuit (SCP), overvoltage (OVP) and overtemperature (OTP)
- 3-year product warranty

Pinout		
Pin	Single	Dual
1*	No Pin / BUS / UVLO	
2	+Vin	
3	-Vin	
4	Remote On/Off	
5	+Vout	
6	Trim	Common
7	-Vout	

* If neither BUS nor UVLO is present
 ** UVLO function is optional

Model	Input Voltage Range	Output		Efficiency
		Vnom	I _{max}	
THN 20-3611UIR	9 – 75 VDC (36 VDC nom.)	5.1 VDC	4'000 mA	87%
THN 20-3612UIR		12 VDC	1'670 mA	88%
THN 20-3613UIR		15 VDC	1'330 mA	88%
THN 20-3615UIR		24 VDC	835 mA	88%
THN 20-3622UIR		+12 VDC	835 mA	88%
THN 20-3623UIR	+15 VDC	667 mA	88%	
THN 20-7211UIR	14 – 160 VDC (72 VDC nom.)	5.1 VDC	4'000 mA	87%
THN 20-7212UIR		12 VDC	1'670 mA	88%
THN 20-7213UIR		15 VDC	1'330 mA	88%
THN 20-7215UIR		24 VDC	835 mA	88%
THN 20-7222UIR		+12 VDC	835 mA	88%
THN 20-7223UIR		+15 VDC	667 mA	88%

TEN 20WIR

20 Watt

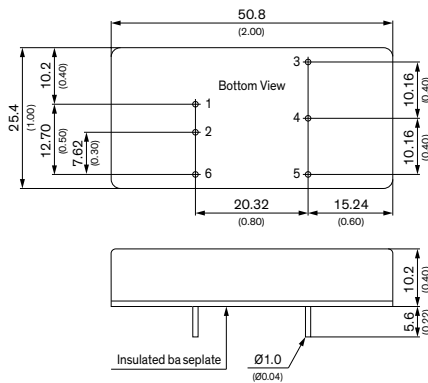

- 2" x 1" metal package
- Ultra wide 4:1 input voltage range 9–36, 18–75, 43–160 VDC
- EN 50155 approval for railway applications
- Thermal shock and vibration resistant according EN 61373
- Input filter meets EN 55032 class B without external components
- High efficiency up to 89%
- No minimum load required
- Operating temperature range -40°C to +85°C
- Under voltage lock-out circuit
- Remote On/Off
- Output voltage adjustable
- Lead free design, RoHS compliant
- 3-year product warranty

* For heat-sink option drawing see data sheet

Pinout		
Pin	Single	Dual
1	+Vin (Vcc)	+Vin (Vcc)
2	-Vin (GND)	-Vin (GND)
3	+Vout	+Vout
4	Trim	Common
5	-Vout	-Vout
6	Remote On/Off	Remote On/Off

Model	Input Voltage Range	Output		Efficiency
		Vnom	I _{max}	
TEN 20-2410WIR	9 – 36 VDC (24 VDC nom.)	3.3 VDC	4500 mA	85%
TEN 20-2411WIR		5 VDC	4000 mA	88%
TEN 20-2412WIR		12 VDC	1670 mA	89%
TEN 20-2413WIR		15 VDC	1330 mA	88%
TEN 20-2422WIR		±12 VDC	±833 mA	88%
TEN 20-2423WIR	±15 VDC	±667 mA	89%	
TEN 20-4810WIR	18 – 75 VDC (48 VDC nom.)	3.3 VDC	4500 mA	85%
TEN 20-4811WIR		5 VDC	4000 mA	88%
TEN 20-4812WIR		12 VDC	1670 mA	89%
TEN 20-4813WIR		15 VDC	1330 mA	88%
TEN 20-4822WIR		±12 VDC	±833 mA	88%
TEN 20-4823WIR	±15 VDC	±667 mA	89%	
TEN 20-7210WIR	43 – 160 VDC (110 VDC nom.)	3.3 VDC	4500 mA	85%
TEN 20-7211WIR		5 VDC	4000 mA	87%
TEN 20-7212WIR		12 VDC	1670 mA	88%
TEN 20-7213WIR		15 VDC	1330 mA	88%
TEN 20-7222WIR		±12 VDC	±833 mA	88%
TEN 20-7223WIR		±15 VDC	±667 mA	89%

TEN 20WIRH

20 Watt

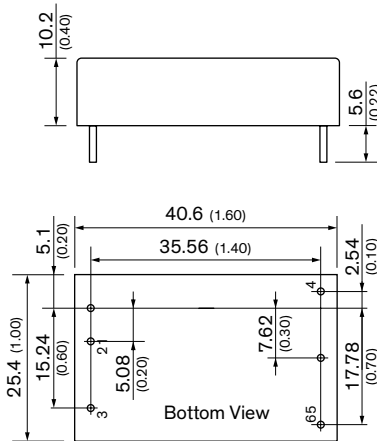

- Compact 1.6" x 1" plastic package
- 3000 VAC reinforced I/O-isolation
- Wide 4:1 input voltage range: 36 – 160 VDC
- EN 50155 approval for railway applications
- Thermal shock and vibration resistant according EN 61373
- High efficiency up to 89%
- Operating temperature range -40°C to +85°C
- Under voltage lock-out circuit
- Remote On/Off and Trim function
- 3-year product warranty

Pinout		
Pin	Single	Dual
1	+Vin	+Vin
2	-Vin	-Vin
3	Ctrl	Ctrl
4	+Vout	+Vout
5	-Vout	-Vout
6	Trim	-Vout

Model	Input Voltage Range	Output		Efficiency
		Vnom	I _{max}	
TEN 20-11011WIRH	36 – 160 VDC	5.1 VDC	4000 mA	89%
TEN 20-11012WIRH		12 VDC	1670 mA	88.5%
TEN 20-11013WIRH		15 VDC	1330 mA	89%
TEN 20-11015WIRH		24 VDC	833 mA	88.5%
TEN 20-11021WIRH		±5 VDC	±2000 mA	86%
TEN 20-11022WIRH		±12 VDC	±833 mA	88.5%
TEN 20-11023WIRH	±15 VDC	±667 mA	89%	

TEN 30UIR

NEW!

30 Watt

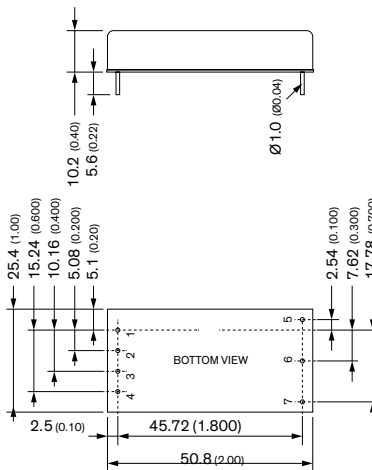

- Compact 2" x 1" housing
- Ultra-wide 12:1 input voltage range: 9–75, 14–160 VDC
- -40°C up to +70°C natural convection cooling without derating
- EN 50155, EN 45545-2 and EN 61373 certified
- Dedicated holdup capacitor connection
- Fully encapsulated
- Reinforced 3000VAC I/O isolation
- Remote on/off and trim function
- Protection against short-circuit (SCP), overvoltage (OVP) and overtemperature (OTP)
- 3-year product warranty

Pinout		
Pin	Single	Dual
1	+Vin	
2	-Vin	
3*	No Pin / BUS / UVLO	
4	Remote On/Off	
5	+Vout	
6	-Vout	Common
7	Trim	-Vout

* Suffix B1 = No Pin
no Suffix = BUS, no UVLO
Suffix A1 = UVLO, no BUS

Model	Input Voltage Range	Output		Efficiency
		Vnom	I _{max}	
TEN 30-3611UIR	9 – 75 VDC (36 VDC nom.)	5.1 VDC	6'000 mA	89%
TEN 30-3612UIR		12 VDC	2'500 mA	90%
TEN 30-3613UIR		15 VDC	2'000 mA	90%
TEN 30-3615UIR		24 VDC	1'250 mA	90%
TEN 30-3622UIR		± 12 VDC	1'250 mA	90%
TEN 30-3623UIR		± 15 VDC	1'000 mA	90%
TEN 30-7211UIR	14 – 160 VDC (72 VDC nom.)	5.1 VDC	6'000 mA	89%
TEN 30-7212UIR		12 VDC	2'500 mA	90%
TEN 30-7213UIR		15 VDC	2'000 mA	90%
TEN 30-7215UIR		24 VDC	1'250 mA	90%
TEN 30-7222UIR		± 12 VDC	1'250 mA	90%
TEN 30-7223UIR		± 15 VDC	1'000 mA	90%

THN 30WIR

30 Watt

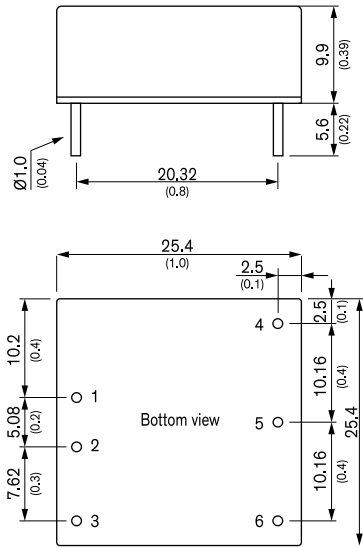

- Compact 1" x 1" x 0.4" standard package
- Wide 4:1 input voltage range 9–36, 18–75, 36–160 VDC
- EN 50155 and EN 61373 approval for railway applications
- Qualification for fire behaviour according to EN 45545-2
- I/O-isolation 3'000 VDC
- High efficiency up to 92%
- Operating temperature range –40°C to +90°C
- Under voltage lock-out circuit
- Adjustable output voltage & Remote On/Off

Pinout		
Pin	Single	Dual
1	+Vin	+Vin
2	–Vin	–Vin
3	Ctrl	Ctrl
4	+Vout	+Vout
5	Trim	Common
6	–Vout	–Vout

Model	Input Voltage Range	Output Vnom	I _{max}	Efficiency
THN 30-2410WIR	9 – 36 VDC (24 VDC nom.)	3.3 VDC	7000 mA	88%
THN 30-2411WIR		5 VDC	6000 mA	89%
THN 30-2412WIR		12 VDC	2500 mA	89%
THN 30-2413WIR		15 VDC	2000 mA	89%
THN 30-2415WIR		24 VDC	1250 mA	90%
THN 30-2422WIR		±12 VDC	±1250 mA	89%
THN 30-2423WIR	±15 VDC	±1000 mA	91%	
THN 30-2425WIR	±24 VDC	±625 mA	91%	
THN 30-4810WIR	18 – 75 VDC (48 VDC nom.)	3.3 VDC	7000 mA	88%
THN 30-4811WIR		5 VDC	6000 mA	90%
THN 30-4812WIR		12 VDC	2500 mA	90%
THN 30-4813WIR		15 VDC	2000 mA	91%
THN 30-4815WIR		24 VDC	1250 mA	92%
THN 30-4822WIR		±12 VDC	±1250 mA	91%
THN 30-4823WIR	±15 VDC	±1000 mA	91%	
THN 30-4825WIR	±24 VDC	±625 mA	92%	
THN 30-7210WIR	36 – 160 VDC (110 VDC nom.)	3.3 VDC	7000 mA	88%
THN 30-7211WIR		5 VDC	6000 mA	90%
THN 30-7212WIR		12 VDC	2500 mA	90%
THN 30-7213WIR		15 VDC	2000 mA	90%
THN 30-7215WIR		24 VDC	1250 mA	91%
THN 30-7222WIR		±12 VDC	±1250 mA	90%
THN 30-7223WIR	±15 VDC	±1000 mA	90%	
THN 30-7225WIR	±24 VDC	±625 mA	91%	

TEN 40WIR

40 Watt

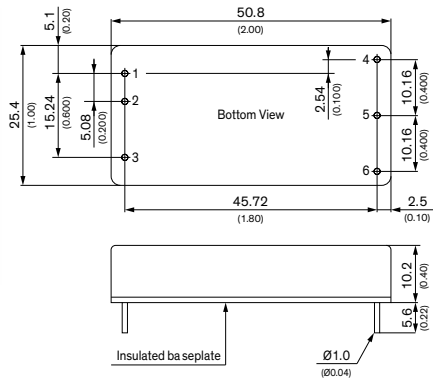

- 2" x 1" metal package
- Ultra wide 4:1 input voltage range 9–36, 18–75, 43–160 VDC
- EN 50155 approval for railway applications
- Thermal shock and vibration resistant according EN 61373
- High efficiency up to 92%
- No minimum load required
- Operating temperature range –40°C to +85°C
- Under voltage lock-out circuit
- Remote On/Off
- Output voltage adjustable
- Lead free design, RoHS compliant
- 3-year product warranty

* For heat-sink option drawing see data sheet

Pinout		
Pin	Single	Dual
1	+Vin (Vcc)	+Vin (Vcc)
2	–Vin (GND)	–Vin (GND)
3	Remote On/Off	Remote On/Off
4	+Vout	+Vout
5	–Vout	Common
6	Trim	–Vout

Model	Input Voltage Range	Output Vnom	I _{max}	Efficiency
TEN 40-2410WIR	9 – 36 VDC (24 VDC nom.)	3.3 VDC	10'000 mA	90%
TEN 40-2411WIR		5 VDC	8000 mA	91%
TEN 40-2412WIR		12 VDC	3333 mA	92%
TEN 40-2413WIR		15 VDC	2666 mA	92%
TEN 40-2415WIR		24 VDC	1666 mA	91%
TEN 40-2422WIR		±12 VDC	±1666 mA	90%
TEN 40-2423WIR	±15 VDC	±1333 mA	90%	
TEN 40-2425WIR	±24 (48*) VDC	±833 mA	91%	
TEN 40-4810WIR	18 – 75 VDC (48 VDC nom.)	3.3 VDC	10'000 mA	90%
TEN 40-4811WIR		5 VDC	8000 mA	91%
TEN 40-4812WIR		12 VDC	3333 mA	92%
TEN 40-4813WIR		15 VDC	2666 mA	92%
TEN 40-4815WIR		24 VDC	1666 mA	91%
TEN 40-4822WIR		±12 VDC	±1666 mA	90%
TEN 40-4823WIR	±15 VDC	±1333 mA	90%	
TEN 40-4825WIR	±24 (48*) VDC	±833 mA	91%	
TEN 40-7210WIR	43 – 160 VDC (110 VDC nom.)	3.3 VDC	10'000 mA	88%
TEN 40-7211WIR		5 VDC	8000 mA	89%
TEN 40-7212WIR		12 VDC	3333 mA	90%
TEN 40-7213WIR		15 VDC	2666 mA	91%
TEN 40-7215WIR		24 VDC	1666 mA	90%
TEN 40-7222WIR		±12 VDC	±1666 mA	89%
TEN 40-7223WIR	±15 VDC	±1333 mA	89%	
TEN 40-7225WIR	±24 (48*) VDC	±833 mA	91%	

*The outputs can also be used in serial circuit for single 48 VDC operation. Free-wheeling diodes are not necessary but recommended for increased performance for start-up with inductive/capacitive load and at dynamic load operation.

TEN 40WIRH **40 Watt**

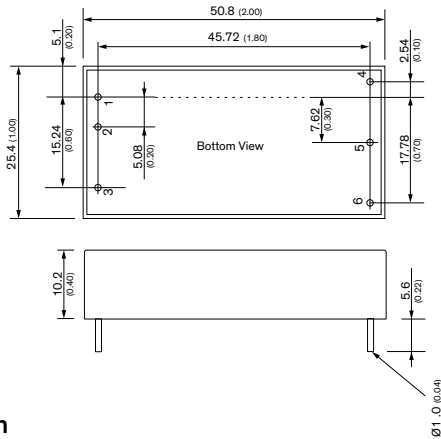

- Compact 2" x 1" plastic package
- 3000 VAC reinforced I/O-isolation
- Wide 4:1 input voltage range: 36 – 160 VDC
- EN 50155 approval for railway applications
- Thermal shock and vibration resistant according EN 61373
- High efficiency up to 90%
- Operating temperature range -40°C to +70°C
- Under voltage lock-out circuit
- Remote On/Off and Trim function
- 3-year product warranty

Pinout		
Pin	Single	Dual
1	+Vin	+Vin
2	-Vin	-Vin
3	Ctrl	Ctrl
4	+Vout	+Vout
5	-Vout	-Vout
6	Trim	-Vout

Model	Input Voltage Range	Output Vnom	Imax	Efficiency
TEN 40-11011WIRH	36 – 160 VDC (110 VDC nom.)	5.1 VDC	8000 mA	88%
TEN 40-11012WIRH		12 VDC	3333 mA	89%
TEN 40-11013WIRH		15 VDC	2666 mA	90%
TEN 40-11015WIRH		24 VDC	1666 mA	89%
TEN 40-11022WIRH		±12 VDC	±1666 mA	88%
TEN 40-11023WIRH		±15 VDC	±1333 mA	89%

TEN 40UIR **NEW!** **40 Watt**

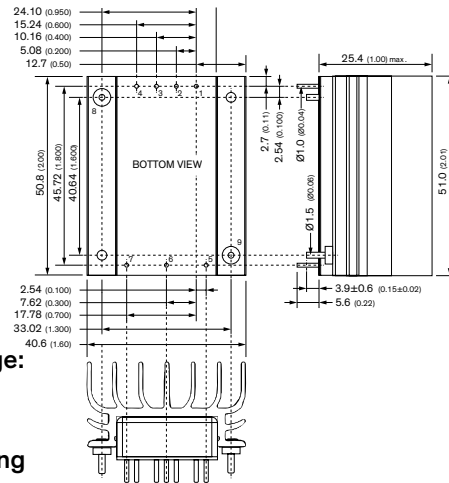
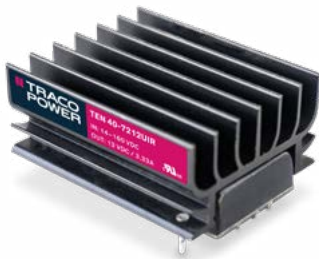

- Compact 2" x 1" housing
- Ultra-wide 12:1 input voltage range: 9–75, 14–160 VDC
- -40°C up to +70°C natural convection cooling without derating
- EN 50155, EN 45545-2 and EN 61373 certified
- Dedicated holdup capacitor connection
- Fully encapsulated
- Reinforced 3000VAC I/O isolation
- Remote on/off and trim function
- Protection against short-circuit (SCP), overvoltage (OVP) and overtemperature (OTP)
- 3-year product warranty

Pinout		
Pin	Single	Dual
1	+Vin	
2	-Vin	
3	No Pin / BUS* / UVLO**	
4	Remote On/Off (CTRL)	
5	+Vout	
6	-Vout	Common
7	Trim	-Vout
8	Heatsink	
9	Heatsink	

Model	Input Voltage Range	Output Vnom	Imax	Efficiency
TEN 40-3611UIR	9 – 75 VDC (36 VDC nom.)	5.1 VDC	8'000 mA	89%
TEN 40-3612UIR		12 VDC	3'330 mA	90%
TEN 40-3613UIR		15 VDC	2'670 mA	90%
TEN 40-3615UIR		24 VDC	1'670 mA	90%
TEN 40-3622UIR		±12 VDC	1'670 mA	90%
TEN 40-3623UIR		±15 VDC	1'330 mA	90%
TEN 40-3611UIR	14 – 160 VDC (72 VDC nom.)	5.1 VDC	8'000 mA	89%
TEN 40-3612UIR		12 VDC	3'330 mA	90%
TEN 40-3613UIR		15 VDC	2'670 mA	90%
TEN 40-3615UIR		24 VDC	1'670 mA	90%
TEN 40-3622UIR		±12 VDC	1'670 mA	90%
TEN 40-3623UIR		±15 VDC	1'330 mA	90%

* BUS function is optional
** UVLO function is optional

TEP 40UIR

40 Watt

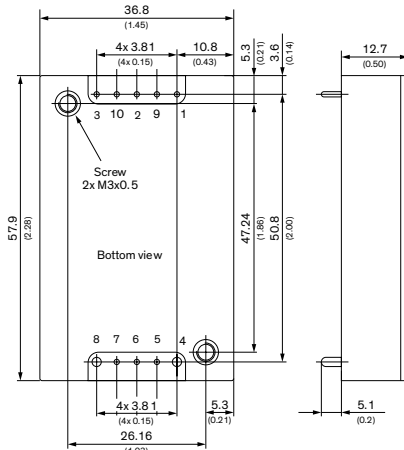

Pin (4, 8): 1.5 (0.06) Pin diameter ±0.1 (±0.004)
 Pin (other): 1.0 (0.04) Screw lock torque: Max. 0.34 N·m (3.5 k gf·cm)

Pin Connection		
Pin	Function	Diameter
1	-Vin	0.04 Inch
2	Remote On/Off	0.04 Inch
3	+Vin	0.04 Inch
4	-Vout	0.06 Inch
5	-Sense	0.04 Inch
6	Trim	0.04 Inch
7	+Sense	0.04 Inch
8	+Vout	0.06 Inch
9	Bus	0.04 Inch
10	UVLO	0.04 Inch

- Compact 2.3" x 1.45" x 0.5" standard package
- Ultra-wide 12:1 input voltage range 9–75, 14–160 VDC
- EN 50155 and EN 61373 approval for railway applications
- Qualification for fire behaviour according to EN 45545-2
- I/O-isolation 3'000 VAC
- High efficiency up to 91%
- Operating temperature range -40°C to +85°C
- Adjustable output voltage, Remote On/Off and adjustable under voltage lock-out

Model	Input Voltage Range	Output Vnom	Output Imax	Efficiency
TEP 40-3611UIR	9 – 75 VDC (36 VDC nom.)	5VDC	8 A	89%
TEP 40-3612UIR		12 VDC	3.33 A	91%
TEP 40-3613UIR		15 VDC	2.67 A	91%
TEP 40-3615UIR		24 VDC	1.67 A	90%
TEP 40-3618UIR		48 VDC	0.83 A	91%
TEP 40-7211UIR	14 – 160 VDC (110 VDC nom.)	5 VDC	8 A	89%
TEP 40-7212UIR		12 VDC	3.33 A	91%
TEP 40-7213UIR		15 VDC	2.67 A	91%
TEP 40-7215UIR		24 VDC	1.67 A	90%
TEP 40-7218UIR		48 VDC	0.83 A	90%

TEN 60WIR

60 Watt

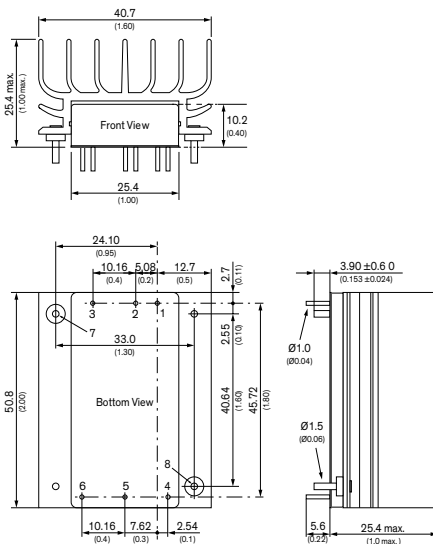

Pinout		
Pin	Single	Dual
1	+Vin (Vcc)	+Vin (Vcc)
2	-Vin (GND)	-Vin (GND)
3	Remote On/Of	Remote On/Of
4	+Vout	+Vout
5	-Vout	Common
6	Trim	-Vout
7	NC	NC
8	NC	NC

- Compact 2" x 1" standard package
- Wide 4:1 input voltage range 9–36, 18–75, 36–160 VDC
- EN 50155 and EN 61373 approval for railway applications
- Qualification for fire behaviour according to EN 45545-2
- I/O-isolation 3'000 VDC
- High efficiency up to 94%
- Operating temperature range -40°C to +85°C
- Under voltage lock-out circuit
- Adjustable output voltage & Remote On/Off

Model	Input Voltage Range	Output Vnom	Output Imax	Efficiency
TEN 60-2411WIR	9 – 36 VDC (24 VDC nom.)	5 VDC	12 A	91%
TEN 60-2412WIR		12 VDC	5 A	93%
TEN 60-2413WIR		15 VDC	4 A	93%
TEN 60-2415WIR		24 VDC	2.5 A	91%
TEN 60-2418WIR		48 VDC	1.25 A	92%
TEN 60-2422WIR	18 – 75 VDC (48 VDC nom.)	±12 VDC	±2.5 A	91%
TEN 60-2423WIR		±15 VDC	±2 A	91%
TEN 60-2425WIR		±24 VDC	±1.25 A	92%
TEN 60-4811WIR		5 VDC	12 A	92%
TEN 60-4812WIR		12 VDC	5 A	93%
TEN 60-4813WIR	15 VDC	4 A	94%	
TEN 60-4815WIR	24 VDC	2.5 A	92%	
TEN 60-4818WIR	48 VDC	1.25 A	92%	
TEN 60-4822WIR	36 – 160 VDC (110 VDC nom.)	±12 VDC	±2.5 A	92%
TEN 60-4823WIR		±15 VDC	±2 A	92%
TEN 60-4825WIR		±24 VDC	±1.25 A	92%
TEN 60-7211WIR		5 VDC	12 A	91%
TEN 60-7212WIR		12 VDC	5 A	92%
TEN 60-7213WIR	15 VDC	4 A	92%	
TEN 60-7215WIR	24 VDC	2.5 A	91%	
TEN 60-7218WIR	48 VDC	1.25 A	91%	
TEN 60-7222WIR	36 – 160 VDC (110 VDC nom.)	±12 VDC	±2.5 A	91%
TEN 60-7223WIR		±15 VDC	±2 A	91%
TEN 60-7225WIR	±24 VDC	±1.25 A	91%	

TEP 60UIR **60 Watt**

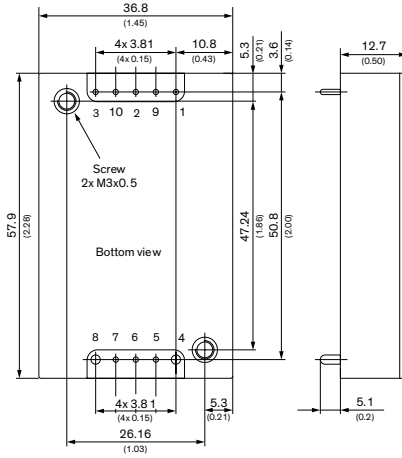

Pin (4, 8): 1.5 (0.06) Pin diameter ±0.1 (±0.004)
 Pin (other): 1.0 (0.04) Screw lock torque: Max. 0.34 N·m (3.5 kg·cm)

Pin Connection		
Pin	Function	Diameter
1	-Vin	0.04 Inch
2	Remote On/Off	0.04 Inch
3	+Vin	0.04 Inch
4	-Vout	0.06 Inch
5	-Sense	0.04 Inch
6	Trim	0.04 Inch
7	+Sense	0.04 Inch
8	+Vout	0.06 Inch
9	Bus	0.04 Inch
10	UVLO	0.04 Inch

Model	Input Voltage Range	Output		Efficiency
		Vnom	I _{max}	
TEP 60-3611UIR	9 – 75 VDC (36 VDC nom.)	5VDC	12 A	89%
TEP 60-3612UIR		12 VDC	5 A	89%
TEP 60-3613UIR		15 VDC	4 A	90%
TEP 60-3615UIR		24 VDC	2.5 A	90%
TEP 60-3618UIR		48 VDC	1.25 A	91%
TEP 60-7211UIR	14 – 160 VDC (110 VDC nom.)	5 VDC	12 A	89%
TEP 60-7212UIR		12 VDC	5 A	89%
TEP 60-7213UIR		15 VDC	4 A	89%
TEP 60-7215UIR		24 VDC	2.5 A	90%
TEP 60-7218UIR		48 VDC	1.25 A	90%

- Compact 2.3" x 1.45" x 0.5" standard package
- Ultra-wide 12:1 input voltage range 9–75, 14–160 VDC
- EN 50155 and EN 61373 approval for railway applications
- Qualification for fire behaviour according to EN 45545-2
- I/O-isolation 3'000 VAC
- High efficiency up to 91%
- Operating temperature range -40°C to +75°C
- Adjustable output voltage, Remote On/Off and adjustable under voltage lock-out

TEP 75WI **75 Watt**

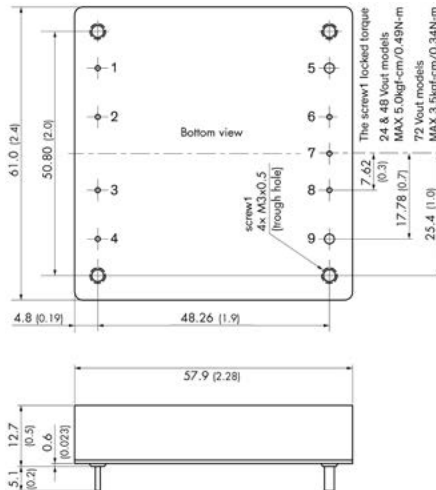

Pinout	
Pin	Function
1	-Vin (GND)
2	Case
3	Remote
4	+Vin (Vcc)
5	-Vout
6	-Sense*
7	Trim
8	+Sense*
9	+Vout

Model	Input Voltage Range	Output		Efficiency
		Vnom	I _{max}	
TEP 75-2411WI	9 – 36 VDC (24 VDC nom.)	5 VDC	15'000 mA	88%
TEP 75-2412WI		12 VDC	6300 mA	88%
TEP 75-2413WI		15 VDC	5000 mA	88%
TEP 75-2415WI		24 VDC	3200 mA	87%
TEP 75-2416WI		28 VDC	2700 mA	87%
TEP 75-2418WI		48 VDC	1600 mA	87%
TEP 75-4811WI	18 – 75 VDC (48 VDC nom.)	5 VDC	15'000 mA	90%
TEP 75-4812WI		12 VDC	6300 mA	90%
TEP 75-4813WI		15 VDC	5000 mA	89%
TEP 75-4815WI		24 VDC	3200 mA	88%
TEP 75-4816WI		28 VDC	2700 mA	88%
TEP 75-4818WI		48 VDC	1600 mA	87%
TEP 75-7211WI	43 – 160 VDC (110 VDC nom.)	5 VDC	15'000 mA	91%
TEP 75-7212WI		12 VDC	6300 mA	91%
TEP 75-7213WI		15 VDC	5000 mA	91%
TEP 75-7215WI		24 VDC	3200 mA	90%
TEP 75-7216WI		28 VDC	2700 mA	90%
TEP 75-7218WI		48 VDC	1600 mA	90%

- Rugged, compact metal case
- Screw terminal adaptor available for easy connection
- EN 50155 approval for railway applications
- Ultra wide 4:1 input voltage range
- Full load operation up to +60°C with convection cooling
- Under voltage lock-out circuit
- Reverse input voltage protection
- Input protection filter
- 3-year product warranty

* Sense line to be connected to the output either at the module or at the load under regard of polarity.

TEP 100UIR

100 Watt

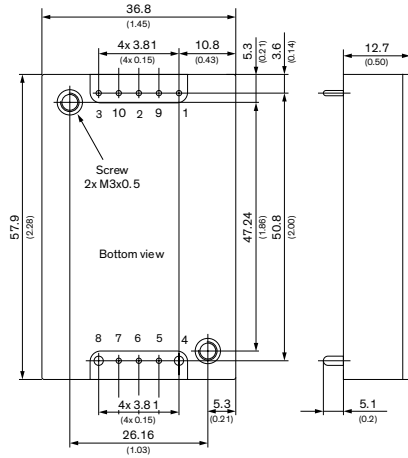

Pin (4, 8): 1.5 (0.06) Pin diameter ±0.1 (±0.004)
 Pin (other): 1.0 (0.04) Screw lock torque: Max. 0.34 N·m (3.5 k gf·cm)

- Compact 2.3" x 1.45" x 0.5" standard package
- Ultra-wide 12:1 input voltage range 9–75, 14–160 VDC
- EN 50155 and EN 61373 approval for railway applications
- Qualification for fire behaviour according to EN 45545-2
- I/O-isolation 3'000 VAC
- High efficiency up to 90%
- Operating temperature range -40°C to +85°C
- Under voltage lock-out circuit
- Adjustable output voltage & Remote On/Off

Pin Connection		
Pin	Function	Diameter
1	-Vin	1.0 mm (0.04)
2	Ctrl	1.0 mm (0.04)
3	+Vin	1.0 mm (0.04)
4	-Vout	1.5 mm (0.06)
5	-Sense	1.0 mm (0.04)
6	Trim	1.0 mm (0.04)
7	+Sense	1.0 mm (0.04)
8	+Vout	1.5 mm (0.06)
9	Bus (option)	1.0 mm (0.04)
10	UVLO (option)	1.0 mm (0.04)

Model	Input Voltage Range	Output		Efficiency
		Vnom	I _{max}	
TEP 100-3611UIR	9 – 75 VDC (36 VDC nom.)	5VDC	20 A	88%
TEP 100-3612UIR		12 VDC	8.35 A	88%
TEP 100-3613UIR		15 VDC	6.7 A	89%
TEP 100-3615UIR		24 VDC	4.2 A	88%
TEP 100-3618UIR		48 VDC	2.1 A	90%
TEP 100-7211UIR	14 – 160 VDC (110 VDC nom.)	5 VDC	20 A	88%
TEP 100-7212UIR		12 VDC	8.35 A	88%
TEP 100-7213UIR		15 VDC	6.7 A	88%
TEP 100-7215UIR		24 VDC	4.2 A	88%
TEP 100-7218UIR		48 VDC	2.1 A	89%

TEP 100WIR

100 Watt

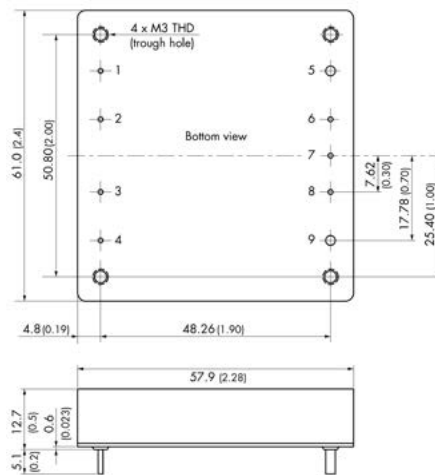

- Compact metal package
- Ultra wide 4:1 input voltage ranges 9–36, 18–75, 43–160 VDC
- EN 50155 approval for railway applications
- Very high efficiency up to 93%
- No minimum load
- Soft start
- Adjustable output voltage +10/-20%
- Sense line
- Remote On/Off input
- Under voltage lock-out circuit

Pinout	
Pin	Function
1	-Vin (GND)
2	Case
3	Remote
4	+Vin (Vcc)
5	-Vout
6	-Sense
7	Trim
8	+Sense
9	+Vout

Model	Input Voltage Range	Output		Efficiency
		Vnom	I _{max}	
TEP 100-2411WIR	9 – 36 VDC (24 VDC nom.)	5 VDC	20'000 mA	93%
TEP 100-2412WIR		12 VDC	8400 mA	90%
TEP 100-2415WIR		24 VDC	4200 mA	90%
TEP 100-2416WIR		28 VDC	3600 mA	90%
TEP 100-2418WIR		48 VDC	2100 mA	90%
TEP 100-4812WIR	18 – 75 VDC (48 VDC nom.)	12 VDC	8400 mA	90%
TEP 100-4815WIR		24 VDC	4200 mA	90%
TEP 100-4816WIR		28 VDC	3600 mA	92%
TEP 100-4818WIR	48 VDC	2100 mA	91%	
TEP 100-7212WIR	43 – 160 VDC (110 VDC nom.)	12 VDC	8400 mA	90%
TEP 100-7215WIR		24 VDC	4200 mA	90%
TEP 100-7216WIR		28 VDC	3600 mA	90%
TEP 100-7218WIR		48 VDC	2100 mA	91%

The screw 1 locked torque (24 and 48Vout models): MAX 5.0kgf-cm/0.49N-m

TEP 150UIR **NEW!** **150 Watt**

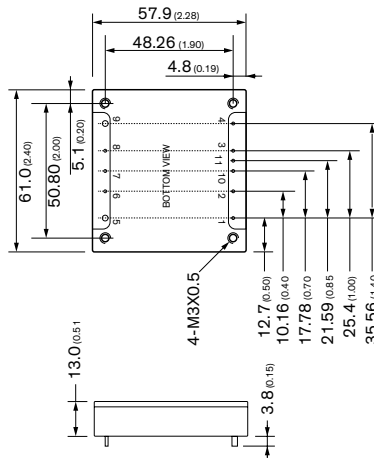

- Ultra-wide 10:1 input voltage range 16 – 160 VDC
- Compact 2.4" x 2.28" x 0.5" standard package (half brick)
- Bus pin to easily extend hold-up time
- EN 50155 and EN 61373 approval for railway applications
- Qualification for fire behavior according to EN 45545-2
- Operating temperature range -40°C to +75°C
- I/O-isolation 3'000 VAC
- High efficiency up to 93%
- Adjustable output voltage, Remote On/Off and adjustable under voltage lock-out
- 3-year product warranty

Pinout	
Pin	Single
1	-Vin
2	BUS
3	Ctrl
4	+Vin
5	-Vout
6	-Sense
7	Trim
8	+Sense
9	+Vout
10	UVLO
11	Pulse Out

Model	Input Voltage Range	Output		Efficiency
		Vnom	I _{max}	
TEP 150-7211UIR	16 – 160 VDC (72 VDC nom.)	5 VDC	30'000 mA	91%
TEP 150-7212UIR		12 VDC	12'500 mA	93%
TEP 150-7213UIR		15 VDC	10'000 mA	92%
TEP 150-7215UIR		24 VDC	6300 mA	89%
TEP 150-7218UIR		48 VDC	3200 mA	93%

TEP 160WIR **160 Watt**

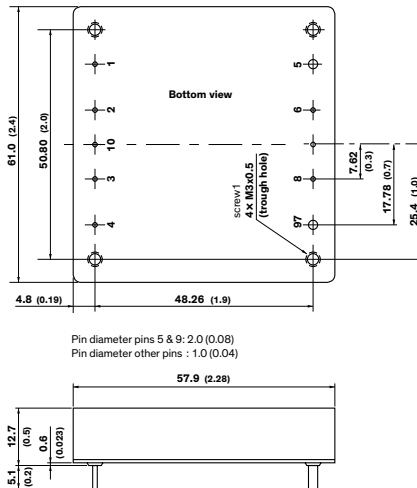

- Compact metal package
- Ultra wide 4:1 input voltage ranges 9–36, 18–75, 43–160 VDC
- EN 50155 approval for railway applications
- Very high efficiency up to 91%
- No minimum load
- Soft start
- Adjustable output voltage +10/-20%
- Sense line
- Remote On/Off input
- Under voltage lock-out circuit

Pinout		
Pin	Function	Pin Diameter
1	-Vin (GND)	1 mm (0.04)
2	Case	1 mm (0.04)
3	Remote	1 mm (0.04)
4	+Vin (Vcc)	1 mm (0.04)
5	-Vout	2 mm (0.08)
6	-Sense	1 mm (0.04)
7	Trim	1 mm (0.04)
8	+Sense	1 mm (0.04)
9	+Vout	2 mm (0.08)
10	Sync (on demand)	1 mm (0.04)

Model	Input Voltage Range	Output		Efficiency
		Vnom	I _{max}	
TEP 160-2412WIR	9 – 36 VDC (24 VDC nom.)	12 VDC	12'000 mA	90%
TEP 160-2413WIR		15 VDC	9500 mA	91%
TEP 160-2415WIR		24 VDC	6000 mA	90%
TEP 160-2416WIR		28 VDC	5000 mA	90%
TEP 160-2418WIR		48 VDC	3000 mA	90%
TEP 160-4812WIR	18 – 75 VDC (48 VDC nom.)	12 VDC	13'000 mA	91%
TEP 160-4813WIR		15 VDC	10'000 mA	91%
TEP 160-4815WIR		24 VDC	6500 mA	91%
TEP 160-4816WIR		28 VDC	5500 mA	91%
TEP 160-4818WIR		48 VDC	3200 mA	91%
TEP 160-7212WIR	43 – 160 VDC (110 VDC nom.)	12 VDC	15'000 mA	90%
TEP 160-7213WIR		15 VDC	12'000 mA	90%
TEP 160-7215WIR		24 VDC	7500 mA	90%
TEP 160-7216WIR		28 VDC	6500 mA	90%
TEP 160-7218WIR		48 VDC	3800 mA	90%

TEP 200WIR

200 Watt

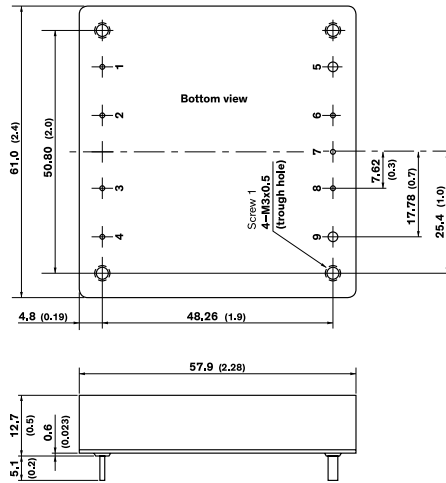

Model	Input Voltage Range	Output Vnom	Imax	Efficiency
TEP 200-2412WIR	9 – 36 VDC (24 VDC nom.)	12 VDC	15'000 mA	89%
TEP 200-2413WIR		15 VDC	12'000 mA	90%
TEP 200-2415WIR		24 VDC	7500 mA	90%
TEP 200-2416WIR		28 VDC	6500 mA	90%
TEP 200-2418WIR	18 – 75 VDC (48 VDC nom.)	48 VDC	3700 mA	89%
TEP 200-4812WIR		12 VDC	18'000 mA	90%
TEP 200-4813WIR		15 VDC	14'000 mA	91%
TEP 200-4815WIR		24 VDC	9000 mA	90%
TEP 200-4816WIR	43 – 160 VDC (110 VDC nom.)	28 VDC	7500 mA	91%
TEP 200-4818WIR		48 VDC	4500 mA	90%
TEP 200-7212WIR		12 VDC	20'000 mA	89%
TEP 200-7213WIR		15 VDC	16'000 mA	90%
TEP 200-7215WIR	43 – 160 VDC (110 VDC nom.)	24 VDC	10'000 mA	89%
TEP 200-7216WIR		28 VDC	8500 mA	90%
TEP 200-7218WIR		48 VDC	5000 mA	89%

- Compact metal package
- Ultra wide 4:1 input voltage ranges 9–36, 18–75, 43–160 VDC
- EN 50155 approval for railway applications
- Very high efficiency up to 91%
- No minimum load
- Soft start
- Under voltage lock-out circuit
- Adjustable output voltage +10 / -20%
- Sense line

Pinout	
Pin	Function
1	-Vin (GND)
2	NC
3	Remote
4	+Vin (Vcc)
5	-Vout
6	-Sense
7	Trim
8	+Sense
9	+Vout

TEP 200UIR

NEW!

200 Watt

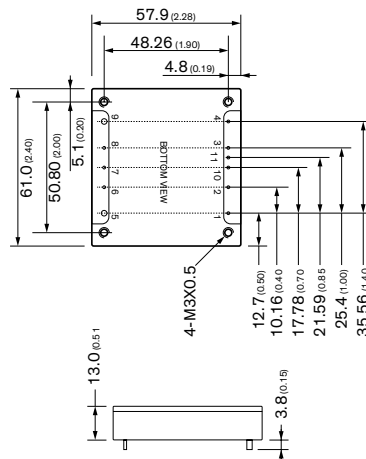

Model	Input Voltage Range	Output Vnom	Imax	Efficiency
TEP 200-7211UIR	16 – 160 VDC (72 VDC nom.)	5 VDC	40'000 mA	91%
TEP 200-7212UIR		12 VDC	16'800 mA	93%
TEP 200-7213UIR		15 VDC	13'400 mA	92%
TEP 200-7215UIR		24 VDC	8400 mA	89%
TEP 200-7218UIR	16 – 160 VDC (72 VDC nom.)	48 VDC	4200 mA	93%

- Ultra-wide 10:1 input voltage range 16 – 160 VDC
- Compact 2.4" x 2.28" x 0.5" standard package (half brick)
- Bus pin to easily extend hold-up time
- EN 50155 and EN 61373 approval for railway applications
- Qualification for fire behavior according to EN 45545-2
- Operating temperature range -40°C to +70°C
- I/O-isolation 3'000 VAC
- High efficiency up to 92%
- Adjustable output voltage, Remote On/Off and adjustable under voltage lock-out
- 3-year product warranty

Pinout		
Pin	A-Type	B-Type
1	-Vin	-Vin
2	BUS	BUS
3	Ctrl	UVLO
4	+Vin	+Vin
5	-Vout	-Vout
6	-Sense	-Sense
7	Trim	Trim
8	+Sense	+Sense
9	+Vout	+Vout
10	UVLO	Ctrl
11	Pulse Out	Pulse Out

Railway DC/DC Converters (Off-Board Mounting)

20 – 300 watt

- Chassis mountable with integrated heatsink
- Spring-clamps or screw terminals
- Integrated EMI filters (model dependent)
- EN 50155 approved for rolling stock
- EN 61373 approved for shock & vibration
- Extended operating temperature range: $-40\text{ }^{\circ}\text{C}$ up to $+105\text{ }^{\circ}\text{C}$ (model dependent)
- Wide input voltage ranges: 9 – 36, 18 – 75, 43 – 160 VDC
- 3-year product warranty



TEQ 20WIR

20 Watt

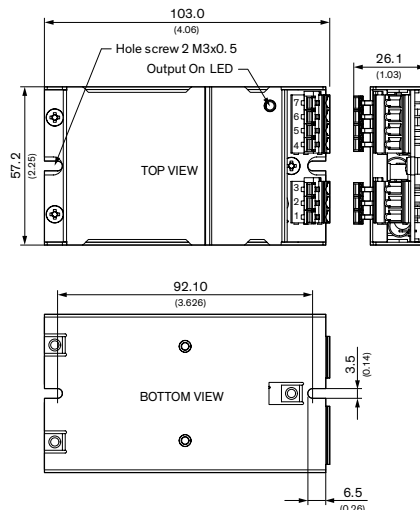

- High power block with excellent thermal convection
- Operating temperature $-40\text{ }^{\circ}\text{C}$ to $+93\text{ }^{\circ}\text{C}$
- Ultra wide 4:1 input voltage range
- EN 50155 approval for railway applications
- Excellent efficiency up to 88%
- Input filter meet EN 55032 class B
- I/O isolation up to 2250 VDC
- Under voltage lock-out circuit
- Protection against overvoltage, overtemperature and short circuit
- Output LED indicator

Pinout		
Pin	Single	Dual
1	+Vin	+Vin
2	-Vin (GND)	-Vin (GND)
3	NC	NC
4	NC	-Vout
5	-Vout	Common
6	+Vout	Common
7	NC	+Vout

Model	Input Voltage Range	Output		Efficiency
		Vnom	I _{max}	
TEQ 20-2411WIR	9 – 36 VDC (24 VDC nom.)	5 VDC	4000 mA	87%
TEQ 20-2412WIR		12 VDC	1670 mA	88%
TEQ 20-2413WIR		15 VDC	1330 mA	87%
TEQ 20-2415WIR		24 VDC	833 mA	87%
TEQ 20-2422WIR		± 12 VDC	833 mA	87%
TEQ 20-2423WIR	± 15 VDC	667 mA	88%	
TEQ 20-4811WIR	18 – 75 VDC (48 VDC nom.)	5 VDC	4500 mA	87%
TEQ 20-4812WIR		12 VDC	1670 mA	88%
TEQ 20-4813WIR		15 VDC	1330 mA	88%
TEQ 20-4815WIR		24 VDC	833 mA	87%
TEQ 20-4822WIR		± 12 VDC	833 mA	87%
TEQ 20-4823WIR	± 15 VDC	667 mA	88%	
TEQ 20-7211WIR	43 – 160 VDC (110 VDC nom.)	5 VDC	4500 mA	86%
TEQ 20-7212WIR		12 VDC	1670 mA	87%
TEQ 20-7213WIR		15 VDC	1330 mA	87%
TEQ 20-7215WIR		24 VDC	833 mA	87%
TEQ 20-7222WIR		± 12 VDC	833 mA	87%
TEQ 20-7223WIR	± 15 VDC	667 mA	88%	

TEQ 40WIR **40 Watt**

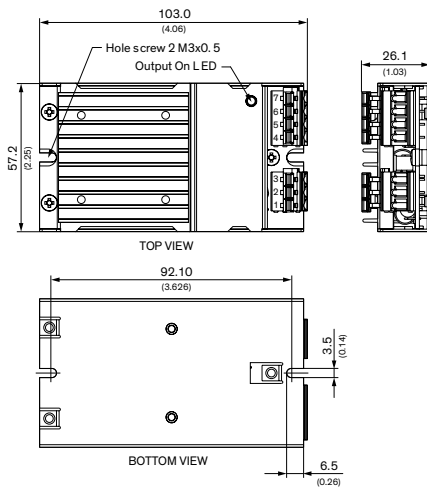

- High power block with excellent thermal convection
- Operating temperature -40°C to $+92^{\circ}$
- Ultra wide 4:1 input voltage range
- EN 50155 approval for railway applications
- Excellent efficiency up to 91%
- Input filter meet EN 55032, class B
- I/O isolation up to 3000 VDC
- Under voltage lock-out circuit
- Protection against overvoltage, overtemperature and short circuit
- Output LED indicator

Pinout		
Pin	Single Output	Dual Output
1	+Vin	+Vin
2	-Vin (GND)	-Vin (GND)
3	NC	NC
4	NC	-Vout
5	-Vout	Common
6	+Vout	Common
7	NC	+Vout

Model	Input Voltage Range	Output Vnom	Output I _{max}	Efficiency
TEQ 40-2411WIR	9 – 36 VDC (24 VDC nom.)	5 VDC	8000 mA	90%
TEQ 40-2412WIR		12 VDC	3330 mA	91%
TEQ 40-2413WIR		15 VDC	2670 mA	91%
TEQ 40-2415WIR		24 VDC	1670 mA	90%
TEQ 40-2422WIR		± 12 VDC	1670 mA	89%
TEQ 40-2423WIR	± 15 VDC	1330 mA	89%	
TEQ 40-2425WIR		± 24 VDC	830 mA	90%
TEQ 40-4811WIR		5 VDC	8000 mA	90%
TEQ 40-4812WIR	18 – 75 VDC (48 VDC nom.)	12 VDC	3330 mA	91%
TEQ 40-4813WIR		15 VDC	2670 mA	91%
TEQ 40-4815WIR		24 VDC	1670 mA	90%
TEQ 40-4822WIR		± 12 VDC	1670 mA	89%
TEQ 40-4823WIR		± 15 VDC	1330 mA	89%
TEQ 40-4825WIR	± 24 VDC	830 mA	90%	
TEQ 40-7211WIR	43 – 160 VDC (110 VDC nom.)	5 VDC	8000 mA	88%
TEQ 40-7212WIR		12 VDC	3330 mA	90%
TEQ 40-7213WIR		15 VDC	2670 mA	90%
TEQ 40-7215WIR		24 VDC	1670 mA	89%
TEQ 40-7222WIR		± 12 VDC	1670 mA	88%
TEQ 40-7223WIR	± 15 VDC	1330 mA	88%	
TEQ 40-7225WIR	± 24 VDC	830 mA	90%	

TEQ 100WIR **100 Watt**

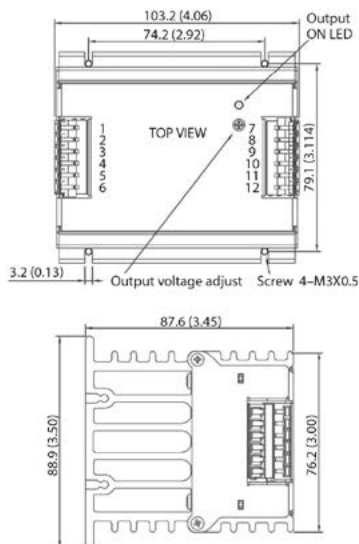

- High power block with excellent thermal convection
- Operating temperature -40°C to $+85^{\circ}\text{C}$ without derating
- Increased shock & vibration resistance
- Ultra wide 4:1 input voltage range
- EN 50155 approval for railway applications
- Excellent efficiency up to 90%
- Input filter meet EN 55032, class A
- I/O isolation 1591 VAC
- Under voltage lock-out circuit
- Soft start

Terminal connection		
Terminal	Pin Function	Recommended Wire
1, 2	-Vin	12 AWG
3	NC	NC
4	On/Off Ctrl	14 – 18 AWG
5, 6	+Vin	12 AWG
7, 8	-Vout	12 AWG
9	-Sense*	14 – 18 AWG
10	+Sense*	14 – 18 AWG
11, 12	+Vout	12 AWG

Model	Input Voltage Range	Output Vnom	Output I _{max}	Efficiency typ.
TEQ 100-2412WIR	10 – 36 VDC (24 VDC nom.)	12 VDC	8400 mA	90%
TEQ 100-2415WIR		24 VDC	4200 mA	90%
TEQ 100-2416WIR		28 VDC	3600 mA	90%
TEQ 100-2418WIR		48 VDC	2100 mA	90%
TEQ 100-4812WIR	19 – 75 VDC (48 VDC nom.)	12 VDC	8400 mA	90%
TEQ 100-4815WIR		24 VDC	4200 mA	90%
TEQ 100-4816WIR		28 VDC	3600 mA	90%
TEQ 100-4818WIR	48 VDC	2100 mA	90%	
TEQ 100-7212WIR	43 – 160 VDC (110 VDC nom.)	12 VDC	8400 mA	89%
TEQ 100-7215WIR		24 VDC	4200 mA	90%
TEQ 100-7216WIR		28 VDC	3600 mA	90%
TEQ 100-7218WIR		48 VDC	2100 mA	90%

* Sense line to be connected to the output either at the module or at the load under regard of polarity.
 • The current rating of the terminal block is 15 A/pole.
 • Using 2 poles in parallel if the peak output current can exceed 15 A.
 • Wire size shall be selected to withstand the peak output current (I_{out max} + Current limitation).

TEP 150WI **150 Watt**



- Shielded metal case with screw terminals
- Ultra wide 4:1 input voltage ranges 9–36, 18–75, 43–160 VDC
- EN 50155 approval for railway applications
- Very high efficiency up to 89%
- Constant current output characteristic for battery load applications
- Optional with input filter to meet EN 55032 class B
- Wide Operating temperature range: –40°C to +75°C
- Under voltage lock-out, overtemperature & reverse input protection
- Easy chassis and wall mounting
- 3-year product warranty

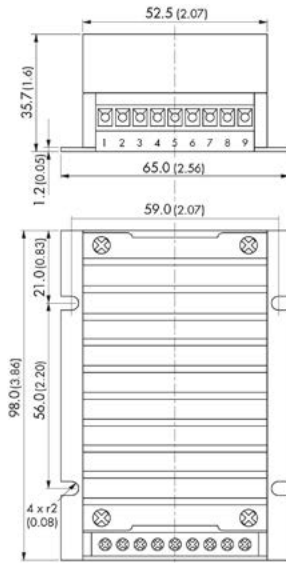

Pinout		
Pin	Function	Recommended Wire
1	+ Vin	14 – 16 AWG
2	+ Vin	14 – 16 AWG
3	– Vin	14 – 16 AWG
4	– Vin	14 – 16 AWG
5	Remote	14 – 24 AWG
6	+ Vout	14 – 16 AWG
7	– Vout	14 – 16 AWG
8	Trim	14 – 24 AWG
9	Trim	14 – 24 AWG

Model	Input Voltage Range	Output Vnom	I _{max}	Efficiency
TEP 150-2412WI	9 – 36 VDC (24 VDC nom.)	12 VDC	12'500 mA	86%
TEP 150-2413WI		15 VDC	10'000 mA	86%
TEP 150-2415WI		24 VDC	6300 mA	87%
TEP 150-2416WI		28 VDC	5400 mA	87%
TEP 150-2418WI	48 VDC	3200 mA	88%	
TEP 150-4812WI	18 – 75 VDC (48 VDC nom.)	12 VDC	12'500 mA	88%
TEP 150-4813WI		15 VDC	10'000 mA	89%
TEP 150-4815WI		24 VDC	6300 mA	89%
TEP 150-4816WI		28 VDC	5400 mA	89%
TEP 150-4818WI	48 VDC	3200 mA	88%	
TEP 150-7212WI	43 – 160 VDC (110 VDC nom.)	12 VDC	12'500 mA	88%
TEP 150-7213WI		15 VDC	10'000 mA	89%
TEP 150-7215WI		24 VDC	6300 mA	89%
TEP 150-7216WI		28 VDC	5400 mA	89%
TEP 150-7218WI	48 VDC	3200 mA	88%	

TEQ 160WIR **160 Watt**

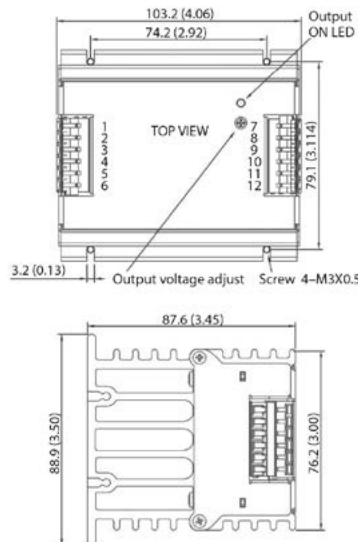

- High power block with excellent thermal convection
- Operating temperature –40°C to +75°C without derating
- Increased shock & vibration resistance
- Ultra wide 4:1 input voltage range
- EN 50155 approval for railway applications
- Excellent efficiency up to 90%
- Input filter meet EN 55032, class A
- I/O insulation 1591 VAC
- Under voltage lock-out circuit
- Soft start

Pin Connection		
Terminal	Pin Function	Recommended Wire
1, 2	–Vin	12 AWG
3	NC	NC
4	On/Off Ctrl	14 – 18 AWG
5, 6	+Vin	12 AWG
7, 8	–Vout	12 AWG
9	–Sense*	14 – 18 AWG
10	+Sense*	14 – 18 AWG
11, 12	+Vout	12 AWG

Model	Input Voltage Range	Output Vnom	I _{max}	Efficiency typ.
TEQ 160-4812WIR	19 – 75 VDC (48 VDC nom.)	12 VDC	13'000 mA	90%
TEQ 160-4815WIR		24 VDC	6500 mA	90%
TEQ 160-4816WIR		28 VDC	5500 mA	90%
TEQ 160-4818WIR		48 VDC	3200 mA	90%
TEQ 160-7212WIR	43 – 160 VDC (110 VDC nom.)	12 VDC	15'000 mA	89%
TEQ 160-7215WIR		24 VDC	7500 mA	89%
TEQ 160-7216WIR		28 VDC	6500 mA	89%
TEQ 160-7218WIR		48 VDC	3800 mA	89%

* Sense line to be connected to the output either at the module or at the load under regard of polarity.
 • The current rating of the terminal block is 15 A/pole.
 • Using 2 poles in parallel if the peak output current can exceed 15 A.
 • Wire size shall be selected to withstand the peak output current (I_{out max} + Current limitation).

TEQ 200WIR **200 Watt**

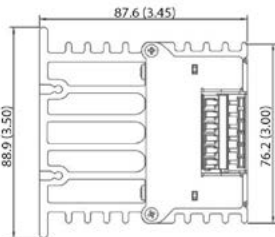
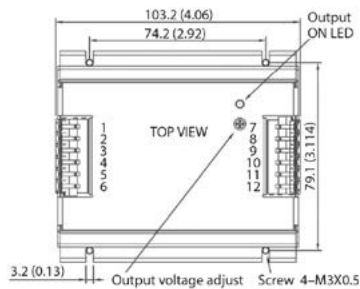

Model	Input Voltage Range	Output		Efficiency typ.
		Vnom	I _{max}	
TEQ 200-4812WIR	19 – 75 VDC (48 VDC nom.)	12 VDC	18'000 mA	89%
TEQ 200-4815WIR		24 VDC	9000 mA	89%
TEQ 200-4816WIR		28 VDC	7500 mA	90%
TEQ 200-4818WIR	48 VDC	4500 mA	89%	
TEQ 200-7212WIR	43 – 160 VDC (110 VDC nom.)	12 VDC	20'000 mA	88%
TEQ 200-7215WIR		24 VDC	10'000 mA	88%
TEQ 200-7216WIR		28 VDC	8500 mA	89%
TEQ 200-7218WIR	48 VDC	5000 mA	88%	

- High power block with excellent thermal convection
- Operating temperature –40°C to +70°C without derating
- Increased shock & vibration resistance
- Ultra wide 4:1 input voltage range
- EN 50155 approval for railway applications
- Excellent efficiency up to 90%
- Input filter meet EN 55032, class A
- I/O insulation 1591 VAC
- Under voltage lock-out circuit
- Soft start

Pin Connection		
Terminal	Pin Function	Recommended Wire
1, 2	–Vin	12 AWG
3	NC	NC
4	Remote	14 – 18 AWG
5, 6	+Vin	12 AWG
7, 8	–Vout	12 AWG
9	–Sense*	14 – 18 AWG
10	+Sense*	14 – 18 AWG
11, 12	+Vout	12 AWG

* Sense line to be connected to the output either at the module or at the load under regard of polarity.
 • The current rating of the terminal block is 15 A/pole.
 • Using 2 poles in parallel if the peak output current can exceed 15 A.
 • Wire size shall be selected to withstand the peak output current (I_{out max} + Current limitation).

TEQ 300WIR **300 Watt**

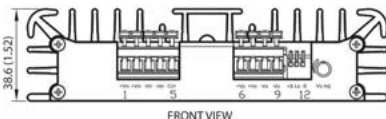
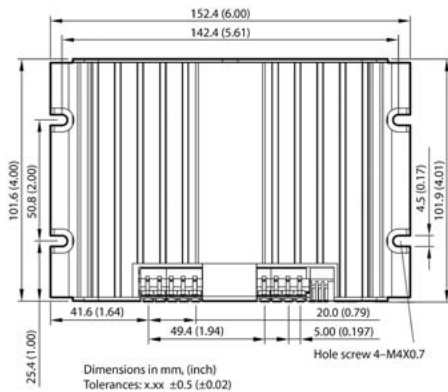

Model	Input Voltage Range	Output		Efficiency typ.
		Vnom	I _{max}	
TEQ 300-4812WIR	19 – 75 VDC (48 VDC nom.)	12 VDC	25'000 mA	89%
TEQ 300-4815WIR		24 VDC	12'500 mA	92%
TEQ 300-4816WIR		28 VDC	10'800 mA	91%
TEQ 300-4818WIR	48 VDC	6300 mA	92%	
TEQ 300-7212WIR	43 – 160 VDC (110 VDC nom.)	12 VDC	25'000 mA	89%
TEQ 300-7215WIR		24 VDC	12'500 mA	91%
TEQ 300-7216WIR		28 VDC	10'800 mA	91%
TEQ 300-7218WIR	48 VDC	6300 mA	92%	

- High power block with excellent thermal convection
- Operating temperature –40°C to +80°C
- Increased shock & vibration resistance
- Ultra wide 4:1 input voltage range
- EN 50155 approval for railway applications
- Excellent efficiency up to 92%
- Constant current output characteristic for battery load applications
- Power sharing (up to 3 pcs in parallel)
- Input filter meet EN 55032, class A
- Under voltage lock-out circuit

Pin Connection		
Terminal	Pin Function	Recommended Wire
1, 2	+Vin	12 – 16 AWG
3, 4	–Vin (GND)	12 – 16 AWG
5	On/Off Ctrl	12 – 16 AWG
6, 7	+Vout	12 – 16 AWG
8, 9	–Vout	12 – 16 AWG
10	+Sense*	20 – 28 AWG
11	LS (Loadshare)	20 – 28 AWG
12	–Sense*	20 – 28 AWG

* Sense line to be connected to the output either at the module or at the load under regard of polarity.
 • Wire size shall be selected to withstand the peak current (I_{out max} + Current limitation).

Accessories

20 – 300 watt

- RIA12 & NF F 01-510 compliant surge filters
- Use with EN 50155-approved products
- Wide input voltage range:
43 – 160VDC
- 3-year product warranty

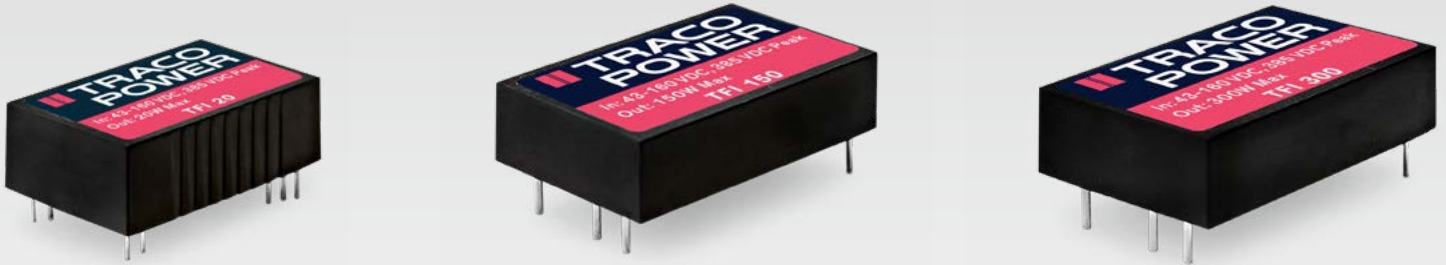

TFI

0–300 Watt

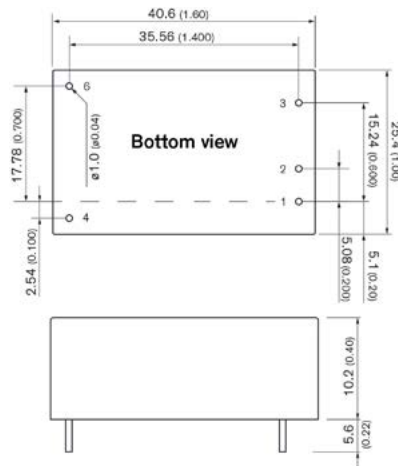

Pinout	
Pin	Function
1	+Vin
2	NC
3	- Vin
4	+Vout
6	- Vout

Note:
Dimension drawing and pinout is only for
TFI 150 and TFI 300.
TFI 20 comes in a DIP-24 package

Model	Input voltage	Power max.
TFI 20*	43–160 VDC	20 W
TFI 150	43–160 VDC	150 W
TFI 300	43–160 VDC	300 W

- Clamps over voltage transients
(up to 385 VDC) at 168 VDC
- Universal use: Can be used with
any DC/DC converter
- Complies with RIA12, NF F 01-510
Surge susceptibilities
- Wide input voltage range:
43 – 160 VDC
- Brownout voltage 36 VDC min.
- Operating temperature range
–40 to +95°C
- 3-year product warranty

* DIP-24 footprint

TRACO Electronic AG is a Swiss company with headquarters based in Baar, Switzerland. As a leading power supply specialist with more than 40 years of experience we are dedicated to the design and manufacturing of high quality DC/DC power conversion products for Railway & Ruggedized applications.

TRACO POWER stocks an average of USD 25+ million in finished goods inventory for immediate shipment through our distribution partners.

TRACO POWER offers extended product life-cycles of typically 10+ years. We understand our customers require high quality solutions to be available from stock in a variety of voltage and power options. Our strong commitment to the reliability of our Railway & Ruggedized products is underlined by a 3 year product warranty.

Our other selection guides / catalogues



International Office

Traco Electronic AG
Sihlbruggstrasse 111
6340 Baar
Switzerland

P +41 43 311 45 11
F +41 43 311 45 45
info@tracopower.com

German Office

Traco Electronic GmbH
Oskar-Messter-Str. 20a
85737 Ismaning/München
Germany

P +49 89 96 11 82-0
F +49 89 96 11 82-20
info@tracopower.de

French Office

Traco Power France
2 rue du nouveau bercy
Bâtiment Le Levant
94220 Charenton Le Pont
France

P +33 (0)9 70 66 76 74
info@tracopower.fr

North America Office

Traco Power North America, Inc.
2025 Gateway Place #330
SAN JOSE, CA 95110
USA

P +1 (408) 916-4570
F +1 (408) 916-4571
salesusa@tracopower.com

Design & Development

Traco Power Solutions Ltd.
Whitemill Industrial Estate
Whitemill Road, Wexford
Y35 YH66, Ireland

P +353 53 9167 700
F +353 53 9167 701
info@tracopower.ie